

EcoFlow DELTA Pro 3

Thank you for choosing
EcoFlow portable power station



Contents

Tutorial Video

About This Manual

Overview

Appearance

Buttons and Switch

LED Indicators

Display Screen

Getting Started

Tips and Tricks

Power On / Off

Power Your Appliances

Charge Your Power Station

Management

Download EcoFlow App

Bind Device and Set Up Internet

Control via Phone

Control via EcoFlow PowerInsight

Explore More

Enhance System Safety

Expand Battery Capacity

Maximize Power Output

Build a Backup System

Storage and Maintenance

Safety Instructions and Compliances

Disclaimer

Safety Instructions

In Case of Emergency



FAQ



EcoFlow App



After-sales
Policy



Community

Tutorial Video

<https://www.youtube.com/watch?v=U8YWKGGeNuWA>

About This Manual

- This manual contains an introduction to this power station, and details on its operation, management, and maintenance. Please note that this manual may be updated without prior notice.
- The availability of certain accessories and features described in this manual may vary depending on your country or region.
- All images displayed in this manual are for demonstrative purposes only. Please refer to the actual product received. The following examples are based on the US version.
- If you are reading this manual in PDF format, please note that you can access it online at [EcoFlow Support](#) for a better experience and the latest updates.

Overview

EcoFlow DELTA Pro 3 (hereinafter referred to as the "DELTA Pro 3", or "the power station") is a power station with a LiFePO4 battery and a capacity of 4096Wh. It has multiple outputs, including standard AC sockets, USB-A ports, USB-C ports, and 12V DC5521 and Anderson ports to support various appliances and devices. The variety of charging options allows you to easily switch between different methods based on your actual needs.

Appendix

What's in the Box

Accessory List

AC Socket Types by Version

Technical Specifications

Appearance



1	Heat Vent	Dissipates the internal heat.
2	Main Power Button	Controls primary power.
3	Display Screen	Displays operating status.
4	USB Output Ports (USB-C / USB-A)	Supplies power via USB-C and USB-A ports to charge phones, laptops, game consoles, or other devices.
5	AC Output Control Button*	Enables or disables the AC output sockets.
6	AC Output Sockets**	Supplies power to AC loads (household appliances or other equipment).
7	Telescopic Handle	Provides a handle to grip when moving the power station.



8	12V DC Output Control Button	Enables or disables the 12V DC output ports.
9	12V DC Output Ports (DC5521 / Anderson)	Supplies power to 12V DC loads via DC5521 and Anderson ports (routers, security cameras, automotive refrigerators, or other devices).
10	REMOTE Port	Supports CAN communication with other EcoFlow devices via an RJ45 ethernet cable.

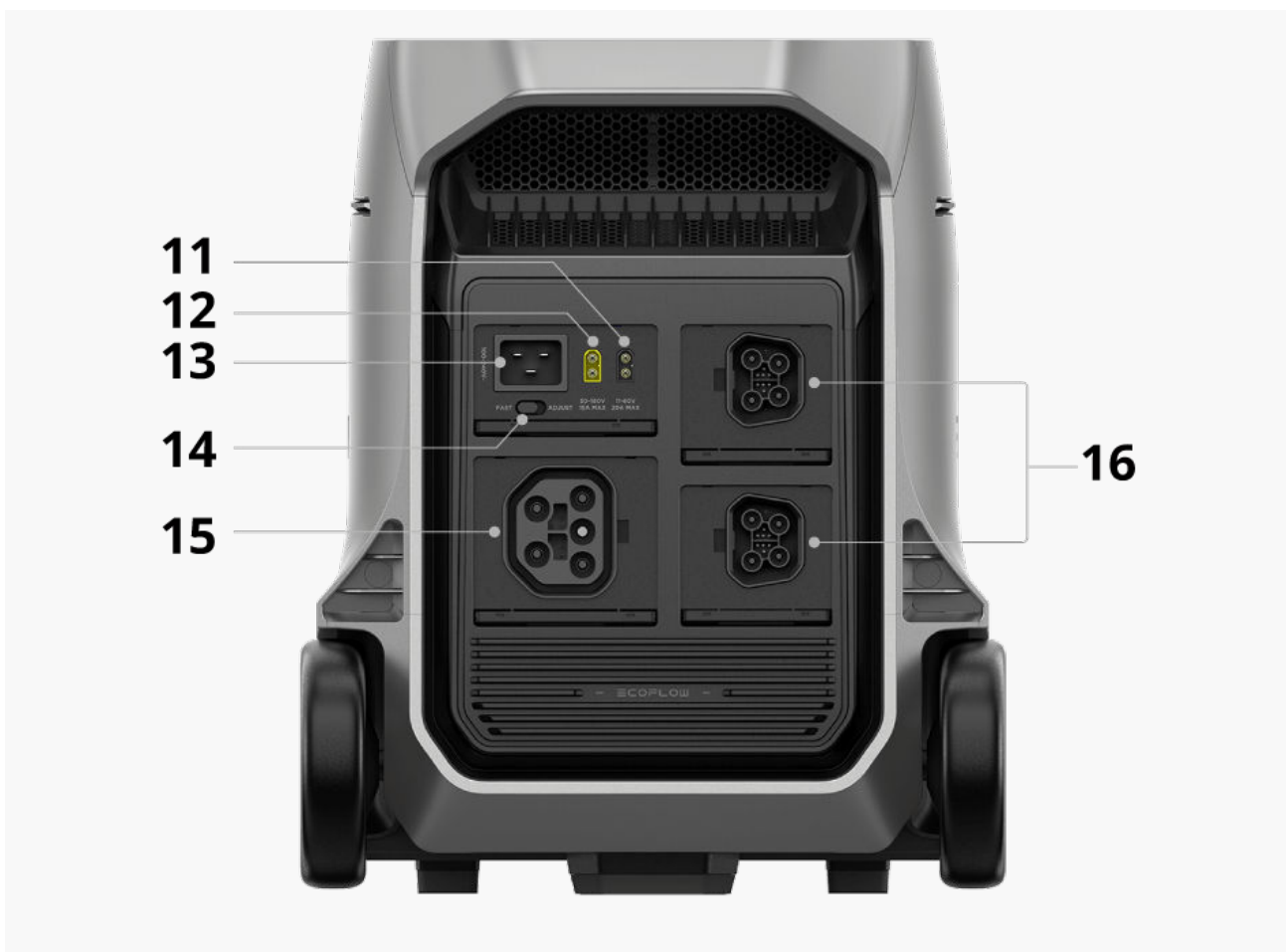

11	Low-PV / Car Input Port (XT60i)	Connects the power station to solar panels or a vehicle power source (cigarette lighter socket or on-board battery charger) for charging.
----	---------------------------------	---

12	High-PV Input Port (XT60)	Connects the power station to solar panels for charging.
----	---------------------------	--

13	AC Input Socket**	Connects the power station to an AC power source for charging.
----	-------------------	--

14	Charge Speed Switch	Switches between charging modes.
----	---------------------	----------------------------------

15	AC POWER IN / OUT Port***	Connects the power station to other EcoFlow devices for charging or increasing power output.
----	---------------------------	--

16	Extra Battery Port***	<p>The port serves the following functions:</p> <ul style="list-style-type: none"> • DC Power Supply: Connects the power station to an EcoFlow smart device to supply power. • DC Charging: Connects the power station to an EcoFlow Alternator Charger or EcoFlow Smart Generator for charging. • Battery Capacity Expansion: Connects the power station to an EcoFlow Smart Extra Battery to expand the battery capacity.
----	-----------------------	---

* For the US or JP version, the power station features two AC Output Control buttons designed to manage different voltage outputs.

** The appearance and specification of AC Output and Input sockets vary according to your local standards.

*** The AC POWER IN / OUT Port and Extra Battery Port on the power station are EcoFlow proprietary ports.

Buttons and Switch



The button serves the following functions:

- **Power On / Off:** Press and hold the button for 2 seconds until the Main Power LED changes.
- **Screen On / Off:** Press once to turn on or off the display screen.
- **Reset IoT Connections:** While the power station is turned off, press and hold the button for at least 5 seconds after the screen turns on to reset all Bluetooth and Wi-Fi connections.

The button serves the following functions:

- **AC Output On / Off:** Press the button once to enable or disable the corresponding power outputs.
- **Change AC Operating Frequency:** Press and hold the button for 10 seconds to change the frequency of the AC power.



3 12V DC Output Control Button

Press the button once to enable or disable the corresponding power outputs.



4 Charge Speed Switch

Switches between charging modes.

- **ADJUST:** Charge the power station at a custom power level that is defined in the EcoFlow app.
- **FAST:** Charge the power station at the maximum supported power level.

Note: Adjustments to the Charge Speed switch are only effective when the power station is being charged via the AC Input Socket.

Notice:

- i To ensure optimal output power for the US or JP version, the AC Output button (HV) and AC Output button (LV) cannot be used at the same time. When one is enabled, the other is automatically disabled.



Tip:

The power station has built-in buzzers. Operations such as pressing a button or adjusting settings in the EcoFlow app may trigger a beeping sound as a reminder. To disable it, switch it off in the EcoFlow app.

LED Indicators

Main Power LED

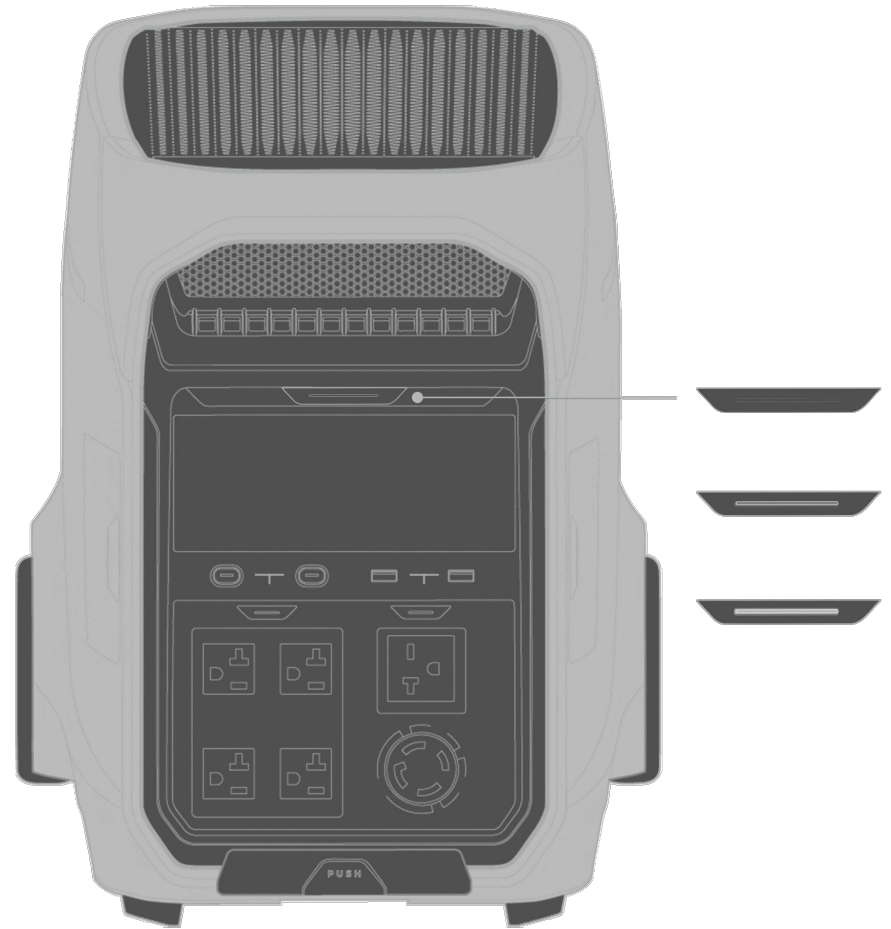

Off: The power station is turned off.

Breathing White: The power station is powered on and functioning normally.

Flashing White: The power station is performing a firmware update.

AC Output LED

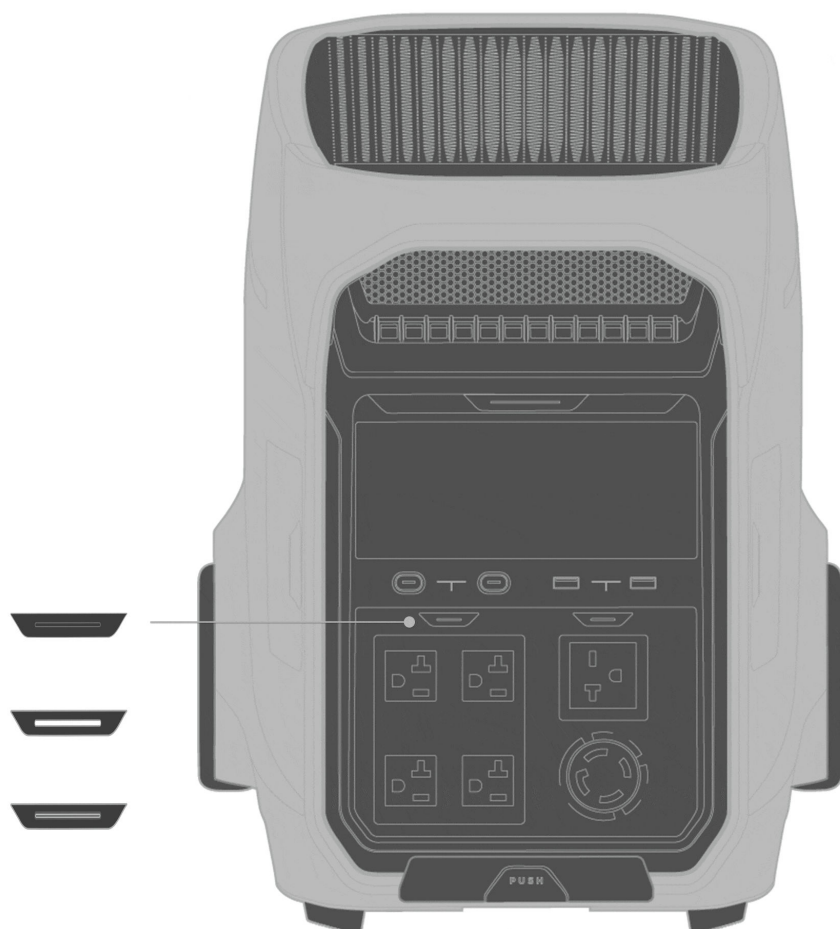

Off: The corresponding AC output sockets are disabled.

Solid White: The corresponding AC output sockets are enabled.

Flashing White: Abnormal power outputs detected. Corresponding AC power output sockets are being disabled. To continue use, press its power button to re-enable it. If the problem reoccurs, upgrade the power station's firmware via the EcoFlow app and try again.

12V DC Output LED



Off: The corresponding DC output ports are disabled.

Solid White: The corresponding DC output ports are enabled.

Flashing White: Abnormal power outputs detected. Corresponding DC power output ports are being disabled. To continue use, press its power button to re-enable it. If the problem reoccurs, upgrade the power station's firmware via the EcoFlow app and try again.

Display Screen

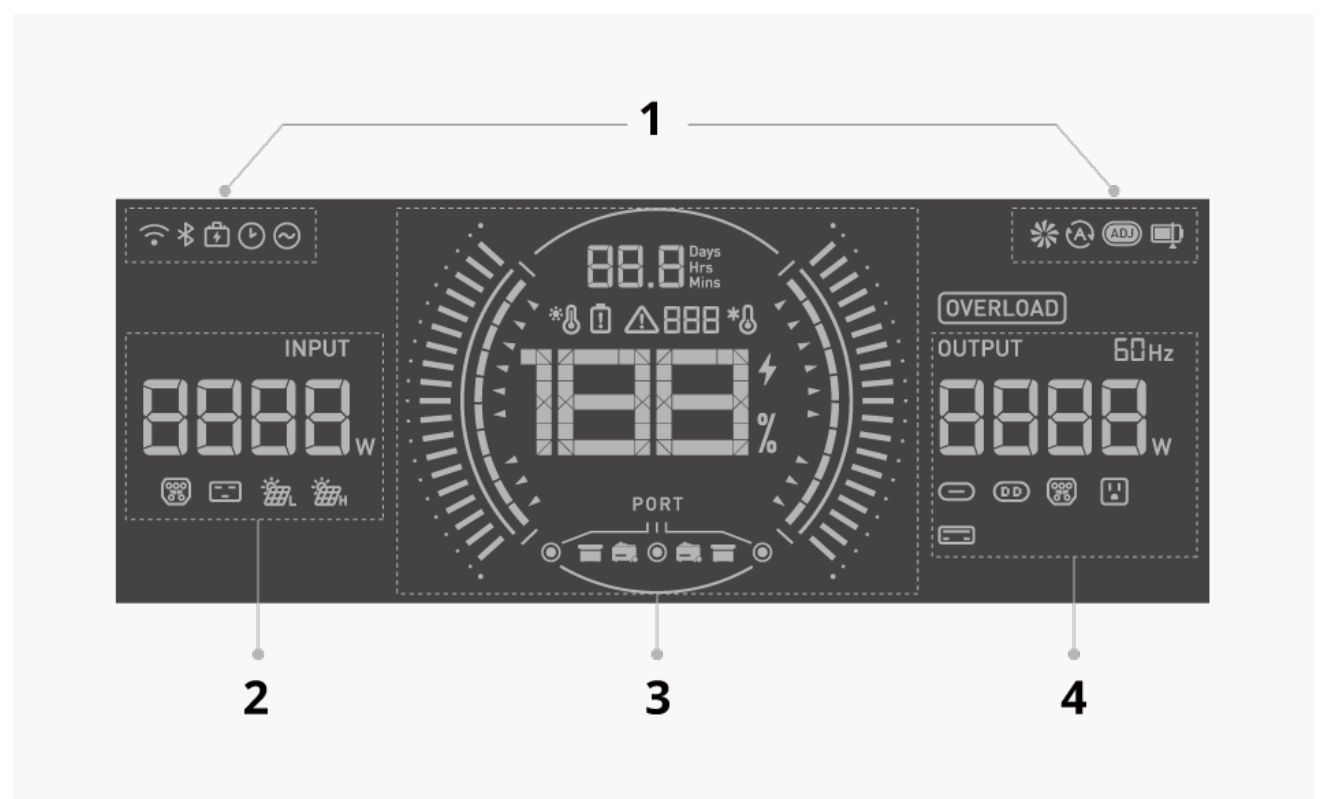

1 Status Bar

- 2 Power Input Details
- 3 Main Display Area
- 4 Power Output Details

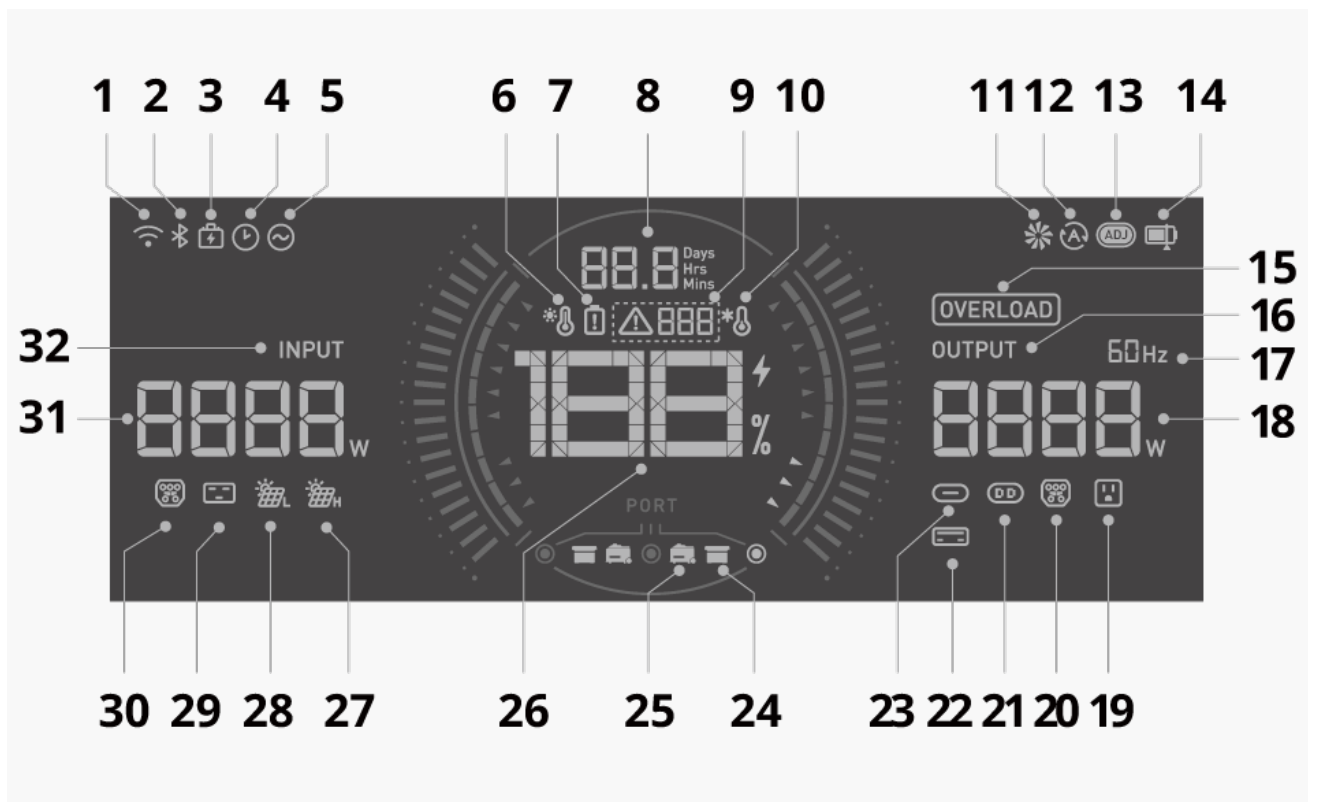

1	Wi-Fi	<p>On: The power station is connected to the internet via a wireless network.</p> <p>Blinking: The power station is connected to a wireless network.</p> <p>Off: Wi-Fi disconnected.</p>
2	Bluetooth	<p>On: The power station is connected to a Bluetooth device.</p> <p>Blinking: The power station is in the Bluetooth pairing process.</p> <p>Off: Bluetooth disconnected.</p>
3	Backup Reserve	<p>On: Backup Reserve mode is enabled in the EcoFlow app.</p>
4	Timer	<p>On: At least one pending timer is configured in the EcoFlow app.</p>
5	Output Port Memory	<p>On: Output Port Memory is enabled. When the power station is turned off, undergoes a firmware upgrade, or reaches the discharging level, it stores the current output state before it powers down. Upon being turned on, completing the firmware upgrade, or exceeding the discharging level, it automatically restores all outputs.</p> <p>Note: The power station will not restore an output if that output port is automatically turned off due to its standby time or if it is manually turned off by pressing its corresponding control button.</p>
6	High Temperature Warning	<p>Blinking: High temperature protection is triggered. Stop operation and place the power station in a location away from heat sources with good ventilation. The alarm will disappear once the power station temperature returns to normal operating levels.</p>
	Battery	<p>Blinking: An error has occurred. Check the EcoFlow in-app</p>

7	Error	instructions for troubleshooting.
8	Remaining Charging / Discharging time	On: Displays the remaining charging or discharging time.
9	Error Code	On: An error has occurred. Check the EcoFlow in-app instructions for troubleshooting.
10	Low Temperature Warning	Blinking: Low temperature protection is triggered. Move the power station to a warmer location to ensure usage within the appropriate temperature range. The warning will disappear once the power station temperature returns to normal operating levels.
11	Fan Status	On: The ventilation fan is running. Blinking: Abnormal fan status.
12	Generator Auto On / Off	On: The automatic start / stop of the connected generator has been set up in the EcoFlow app. This feature is only applicable to an EcoFlow Smart Generator connected to this power station via the Extra Battery port.
13	Adjustable Charging Speed	On: Charge Speed Switch is set to ADJUST. The power station will be charged at the customized speed defined in the EcoFlow app.
14	Charging / Discharging Limit	On: The charge limit or discharge limit is set in the EcoFlow app. Blinking: The discharge limit is reached. The AC outputs and 12V DC outputs cannot be enabled.
15	Overload Warning	Blinking: Overload protection is triggered. Disconnect some devices from the power station to decrease the overall power output. The warning will disappear once the power output returns to its usual level.
16	Output Icon	On: Displays power output details.
17	Frequency	On: Displays operating power frequency.
18	Total Output Power	On: Displays total output power.
19	AC Output Socket	On: The AC output sockets are enabled. Blinking: Port malfunction.
20	AC POWER IN / OUT Port	On: The port is physically connected and has power output. Blinking: Port malfunction.
21	12V DC Output	On: The DC5521 and Anderson ports are enabled. Blinking: Port malfunction.
22	USB-A Output	On: The port is physically connected and has power output. Blinking: Port malfunction.
23	USB-C Output	On: The port is physically connected and has power output. Blinking: Port malfunction.

24	Extra Battery	On: EcoFlow Smart Extra Battery is connected via the Extra Battery port.
25	Smart Generator	On: EcoFlow Smart Generator is connected via the Extra Battery port.
26	Battery Level	On: Displays current battery level.
27	High-PV Input	On: The port is physically connected and has power input. Blinking: <ul style="list-style-type: none"> • Indicates that low light protection has been triggered, or • Indicates overvoltage or undervoltage.
28	Low-PV Input / Car Input	On: The port is physically connected and has power input. Blinking: <ul style="list-style-type: none"> • Indicates that low light protection has been triggered, or • Indicates overvoltage or undervoltage.
29	AC Input Socket	On: The socket is physically connected. Blinking: Port malfunction.
30	AC POWER IN / OUT Port	On: The port is physically connected and has power input. Blinking: Port malfunction.
31	Total Input Power	On: Displays total input power.
32	Input Icon	On: Displays power input details.

Getting Started

Tips and Tricks

- **Port Covers**

Slide the protective covers to reveal or hide electric outlets. For unused ports and sockets, keep the protective cover closed to prevent dust, moisture, or other contaminants from entering.



- **Telescopic Handle & Wheels**

Extend the telescopic handle and easily move the power station on its wheels.



- **Grip Protectors**

Attach the grip protectors to prevent accidental knocks.



Power On / Off



- **Power On / Off:** Press and hold the Main Power button for 2 seconds until the Main Power LED changes.
- **Turn On / Off Screen:** Press the Main Power button once to turn on or turn off the screen.



Tip:

The power station automatically turns on when it's connected to a power source.

Power Your Appliances

Via USB Ports

Connect your devices directly to the USB ports on the power station.

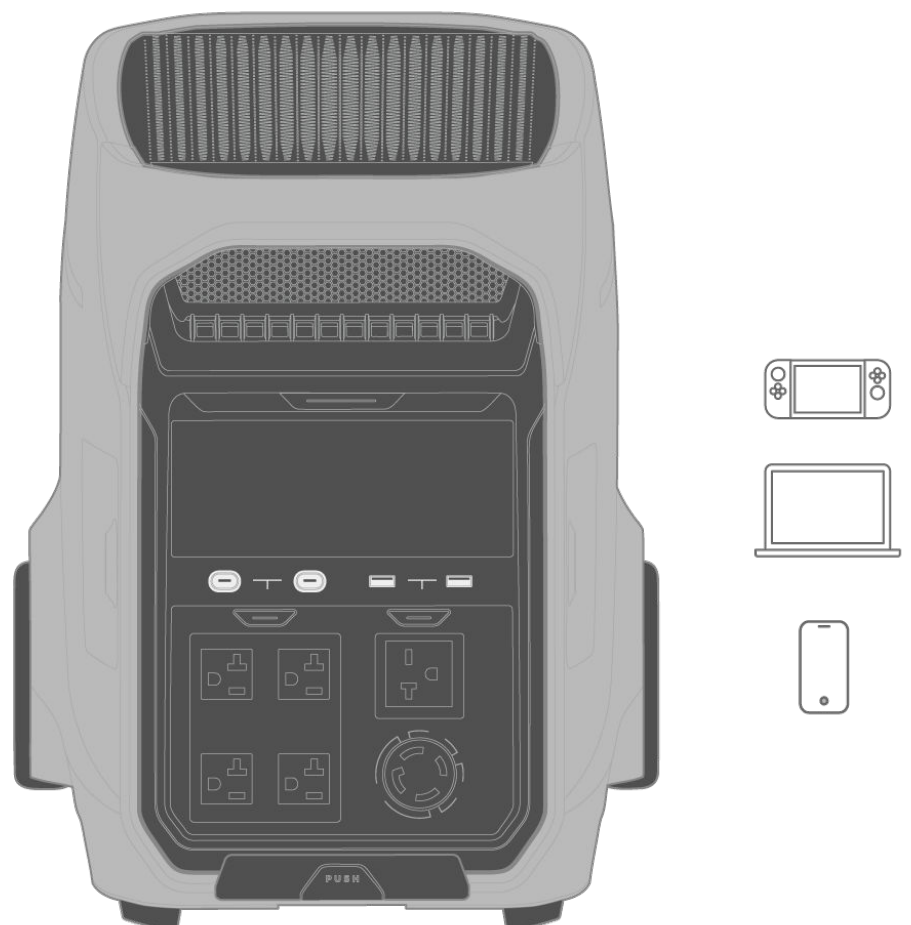

Via AC Output Sockets

1. Press the AC Output Control button once to enable the supply of power.
2. Connect your device to an AC output socket on the power station.



DELTA Pro 3 offers multiple types of AC sockets, enabling it to power a wide range of devices and also adapt to specific scenarios. For example, it can provide power for a leisure battery in a recreational vehicle or serve as a backup power solution integrated into the household circuit.

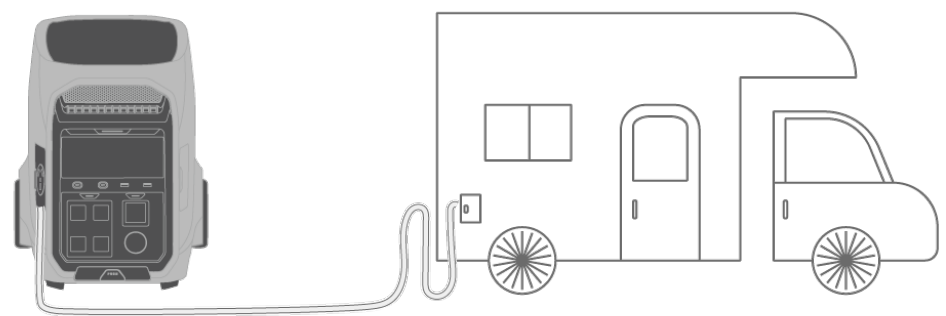
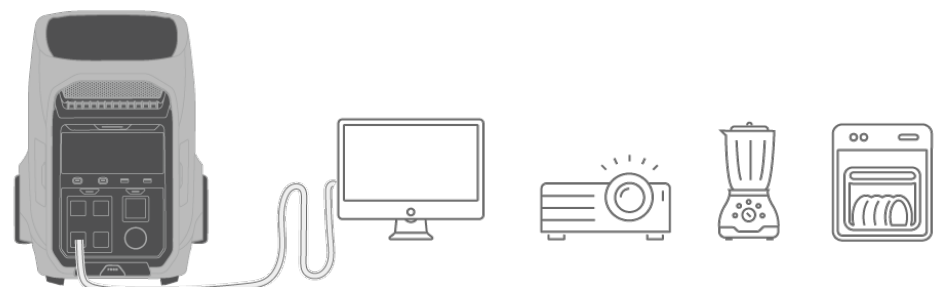

Notices:

1. When the AC POWER IN / OUT port is being used, all AC output sockets and AC input socket will be disabled.
- i 2. To ensure optimal output power for the US/JP version, the AC Output button (HV) and AC Output button (LV) cannot be used at the same time. When one is enabled, the other is automatically disabled.



Tips:

1. The types of AC sockets on the product vary according to your local standards.
2. **AC Timeout Tip:** The AC output port of the power station will automatically turn off if the port is idle for a certain period. When the power station is connected to intermittent loads like refrigerators or air conditioners, this feature may be triggered. To ensure continuous power supply for critical uses, such as storing medicines, vaccines, the perishables, or other valuable items in a refrigerator, set the power station's AC timeout interval to never in the EcoFlow app. Additionally, regularly check the power station's battery level.
3. **If the power output of the AC output sockets unexpectedly turns off:**
 - a. Press the AC Output Button to re-enable AC power output.
 - b. If the problem reoccurs, upgrade the power station's firmware via the EcoFlow app and try again.
 - c. If the problem persists, contact technical support.

Via 12V DC Output Ports

- **DC5521 Port**

1. Press the 12V DC Output button once to enable the DC5521 port.
2. Connect your device to the DC5521 port on the power station.

- **Anderson Port**

1. Press the 12V DC Output button once to enable the Anderson port.
2. Connect your device to the Anderson port on the power station.

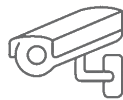
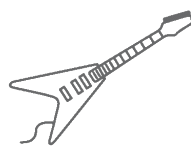

ooo



Tip:

The 12V DC Output ports support a total power output of 378W.

Charge Your Power Station

From a Wall Outlet

Connect the power station's AC Input socket to a wall outlet using the provided AC charging cable.

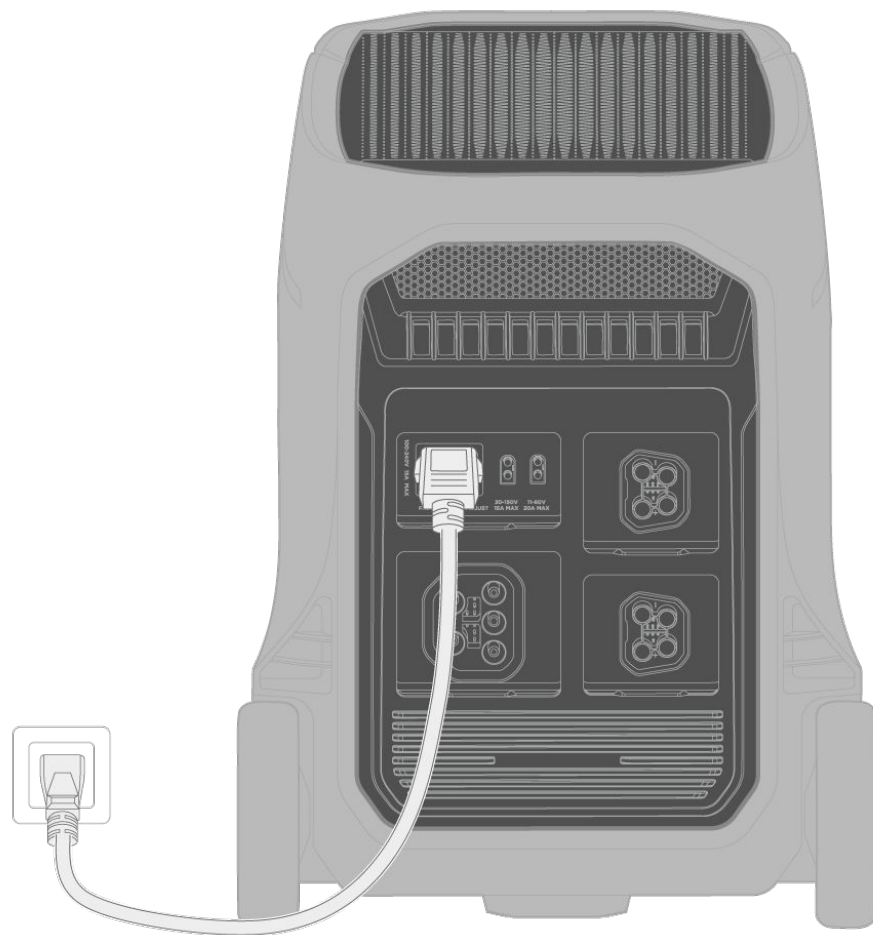

From Solar

The power station supports 2 PV input ports (High-PV and Low-PV).

- **High-PV Input port:**

Specifications: This port supports an input voltage range of 30V-150V, a maximum current of 15A, and a maximum power input of 1600W.

Connection: Connect this port to solar panels using an [EcoFlow Solar to XT60 Charging cable](#).

- **Low-PV Input port:**

Specifications: This port supports an input voltage range of 11V-60V, a maximum current of 20A, and a maximum power input of 1000W.

Connection: Connect this port to solar panels using an [EcoFlow Solar to XT60i Charging Cable](#).

When connecting your solar panels to charge a power station, it's crucial to ensure the connected solar panels are compatible with the specifications of the power station. Here are some basic guidelines that can help you validate your setup:

- 1. For series connection:**

In this setup, the voltage of all connected panels adds up. Ensure the total solar open circuit voltage (Voc) does NOT EXCEED the maximum input voltage (Vmax) of the power station's PV input port.

Overvoltage protection allows the power station to handle up to 155V input for the High-PV port and 62V input for the Low-PV port. However, Voc can fluctuate with temperature changes. Always keep the solar input voltage within the safe operating limits to prevent potential damage to the power station.

- 2. For parallel connection:**

In this setup, the current of all connected panels adds up. Ensure the total solar current (I_{mp}) is CLOSE TO the maximum input current (I_{max}) of the PV input port.

The following image uses the [EcoFlow 400W Portable Solar Panel](#) for demonstration.

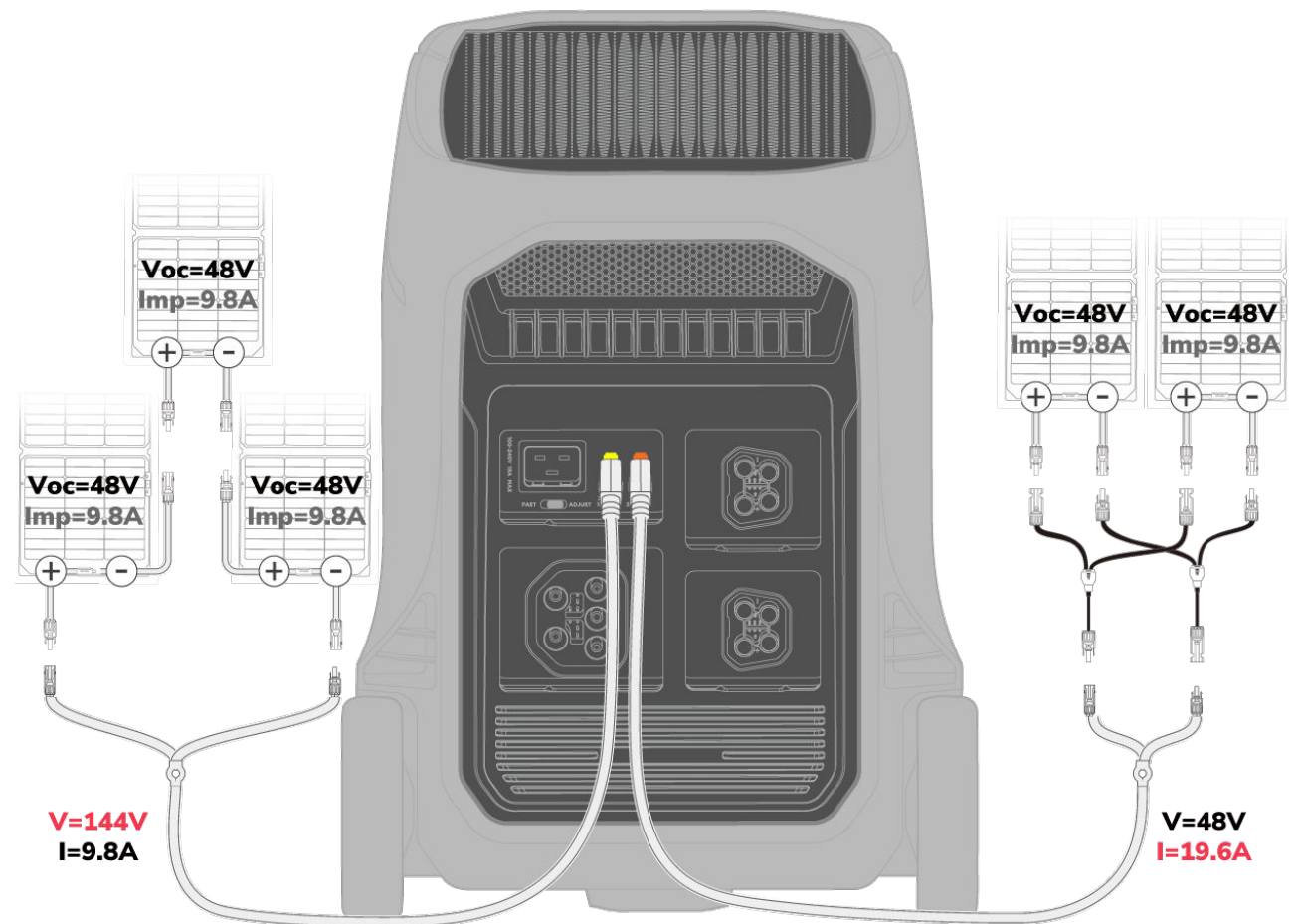

Tips:

1. The actual performance of solar charging can be influenced by various factors, including weather conditions, panel angles, ambient temperature, and so on. To learn more about solar wiring, look at any of the [EcoFlow solar panel user manuals](#).
2. T-branch or Y-branch solar extension cables are required for parallel wiring. They are designed to consolidate multiple leads with the same polarity into one, simplifying the wiring process when connecting the panels to an XT60 / XT60i charging cable.
3. If you find that the charging power levels do not match the specifications of the solar panels, try adjusting the connections to ensure they are secure. Also, ensure that the solar panels are connected to the appropriate solar input port based on their actual specifications.

From a Cigarette Lighter Socket

Connect the power station's Car Input port (XT60i) to a car's cigarette lighter socket using an [EcoFlow Car Charging cable](#).

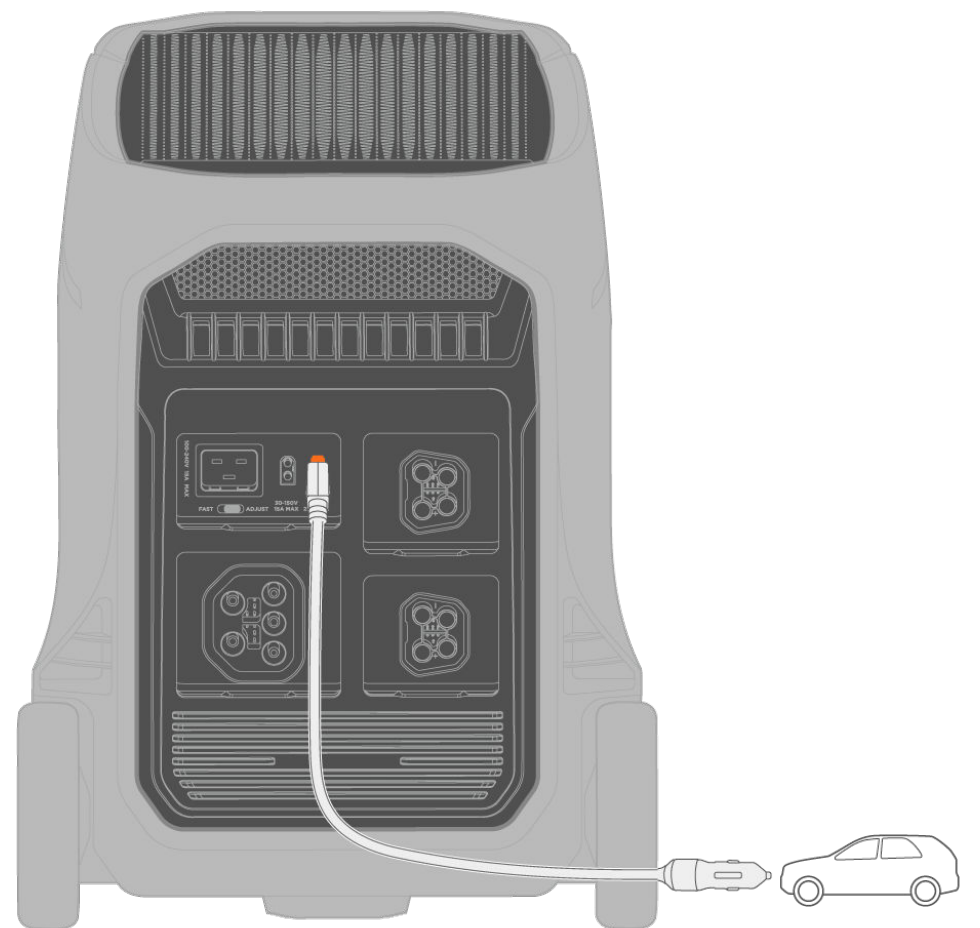

From a DC-DC Battery Charger

Method 1: Via the Extra Battery port (Only Supports EcoFlow Alternator Charger)

1. Install the [DELTA Pro to Smart Generator Adapter](#) into the power station's Extra Battery port.
2. Connect the power station to an [EcoFlow 800W Alternator Charger's](#) XT150 port.

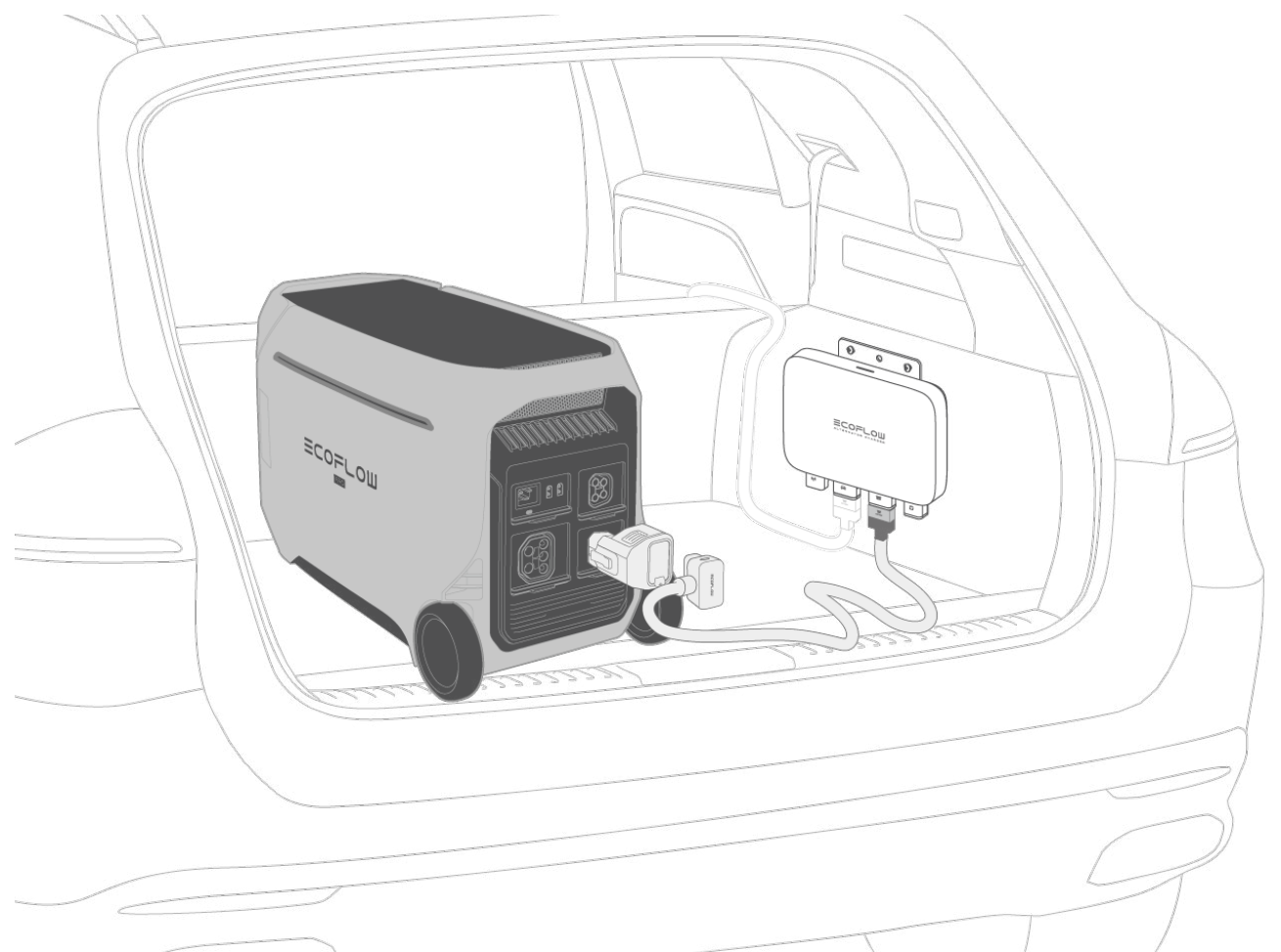

Method 2: Via the Car Input port (XT60i)

Connect the power station's Car Input port to a DC-DC onboard battery charger.

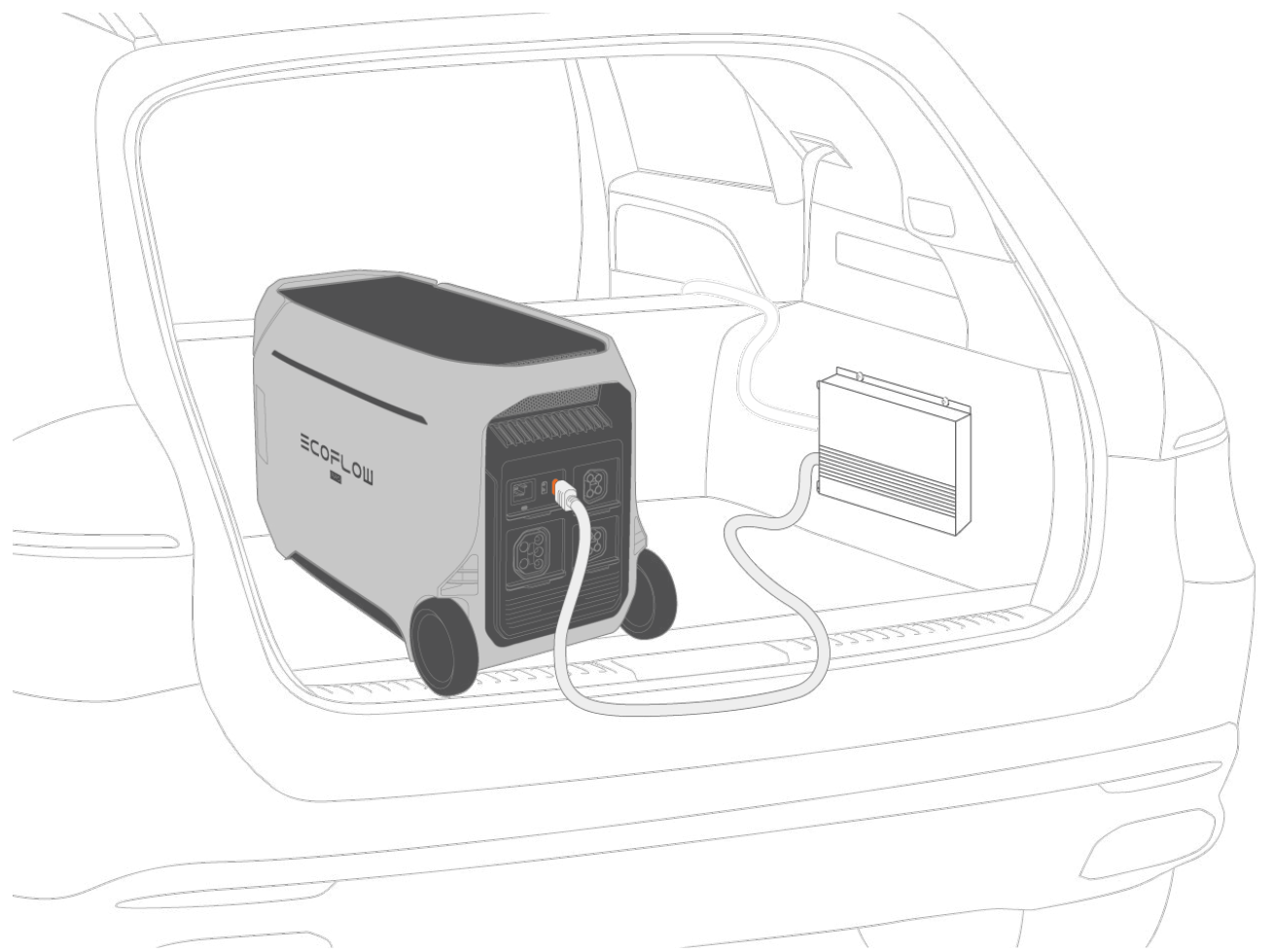

From an EV Charger

Connect the power station's AC POWER IN / OUT port to an EV Charger using an [EcoFlow EV X-Stream Adapter](#).

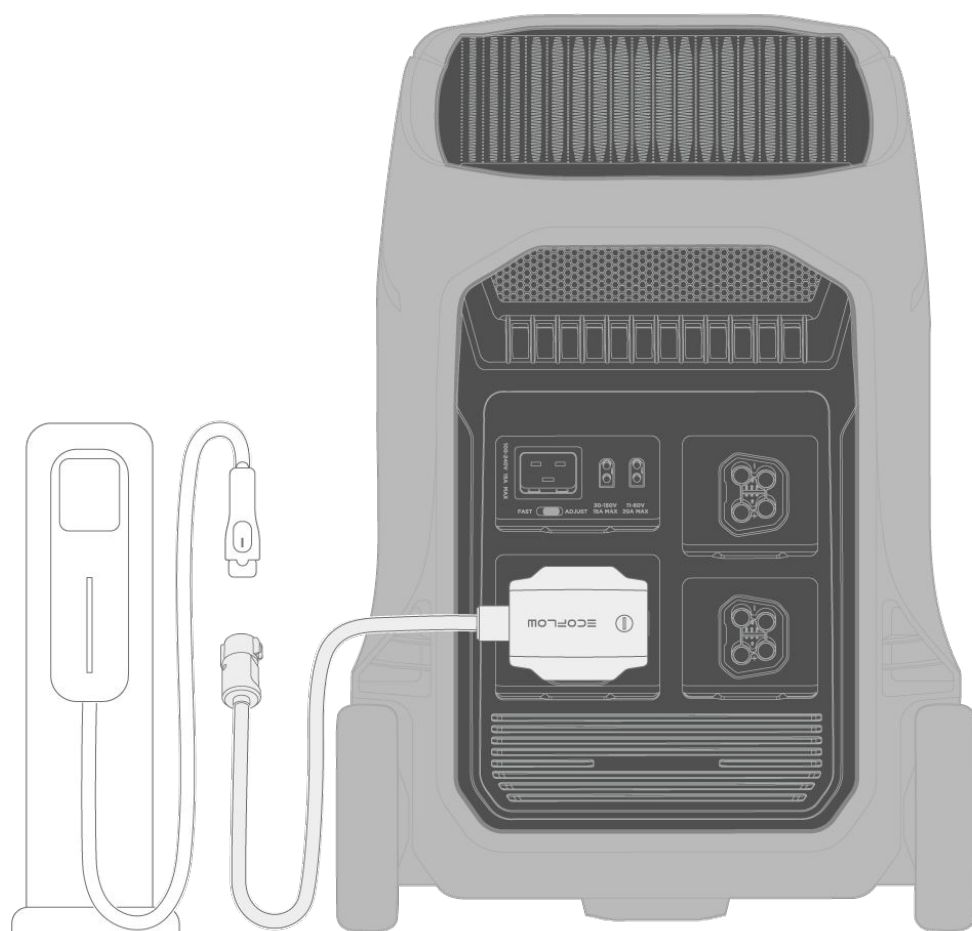

Notice:

-  When charging via an EV charger, make sure the battery level of the power station is above 0%, or higher than the discharging limit defined in the EcoFlow app. Otherwise, the charging process may fail.



Tip:

The power station supports Level 1 and Level 2 AC EV chargers.

From a Generator

Method 1: Via the Extra Battery port (Only Supports EcoFlow Smart

Generators)

1. Install the [DELTA Pro to Smart Generator Adapter](#) into the power station's Extra Battery port.
2. Connect the power station to an EcoFlow generator's XT150 port via the Extra Battery Connection cable.

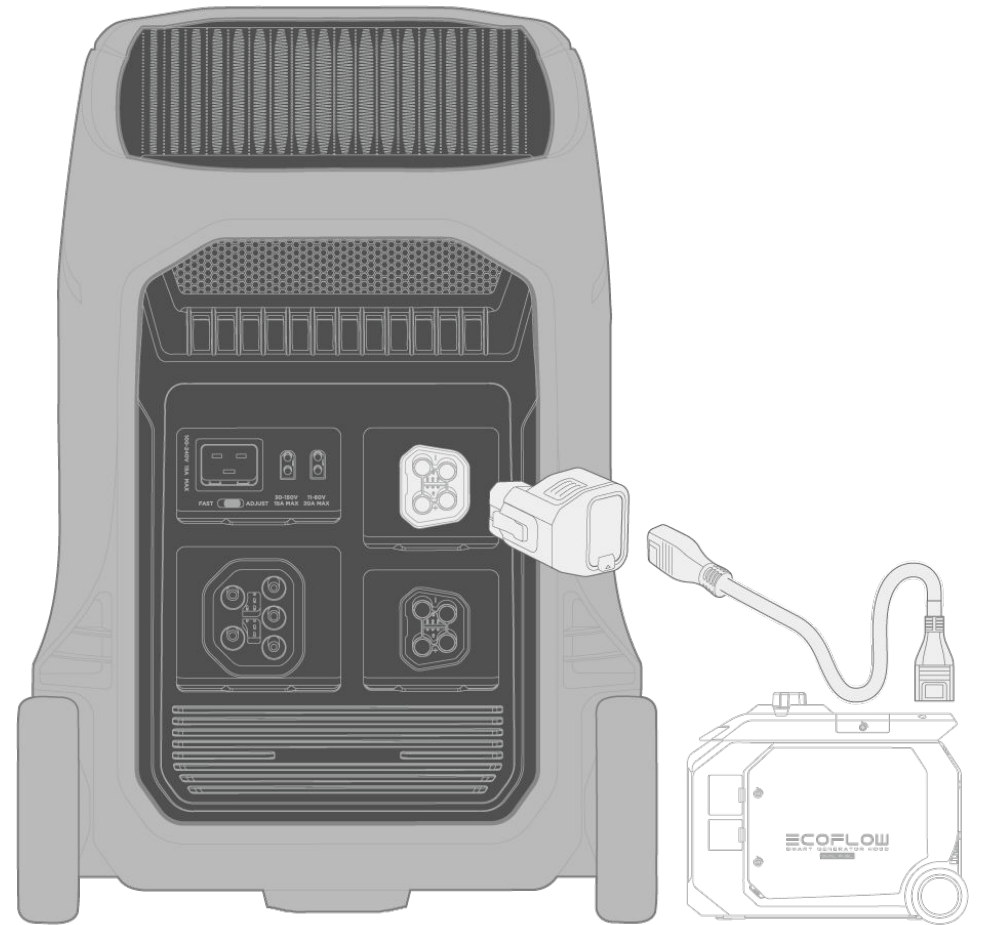

Method 2: Via the AC Input socket

Connect the power station's AC Input socket to a generator using the provided AC charging cable.

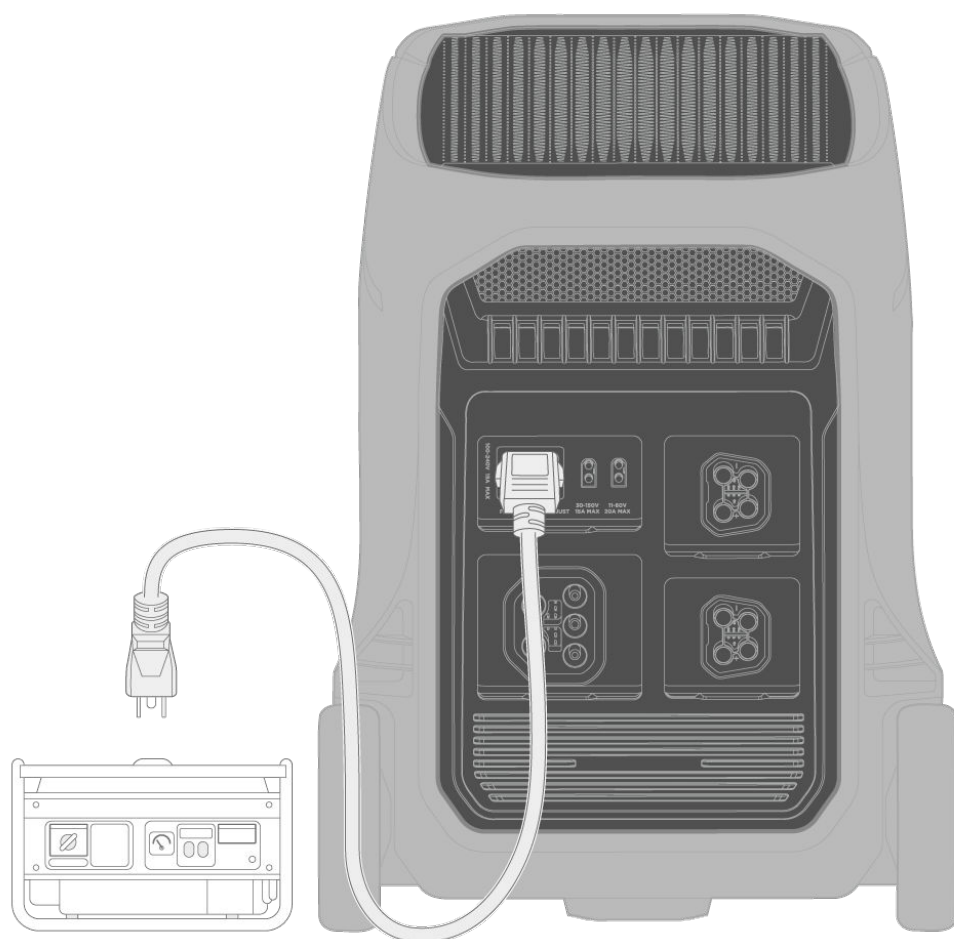

Method 3: Via the AC POWER IN / OUT port

Connect the power station's AC POWER IN / OUT port to the split-phase AC port (L14-30 or L15-30) on a generator using the [EcoFlow AC Generator Charging Adapter](#).

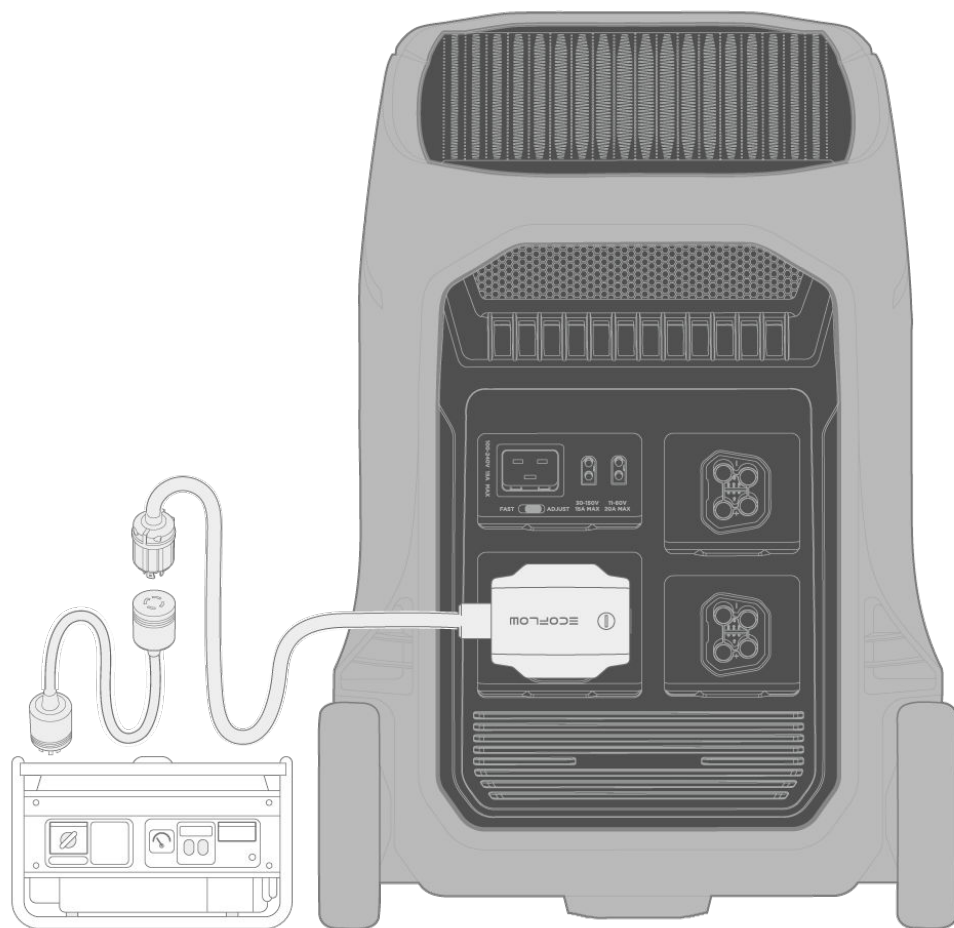

Management

Download EcoFlow App

EcoFlow offers a companion app for device management. With this mobile application, you can:

- Enjoy all-in-one control of your EcoFlow devices from anywhere.
- Monitor power consumption details seamlessly with real-time updates.
- Personalize your energy scheme with an array of customizable options.
- Promptly receive in-app troubleshooting and firmware updates.



Scan the QR code or download it at:
<https://download.ecoflow.com/app>

Bind Device and Set Up Internet

After successfully registering an EcoFlow account, bind your EcoFlow devices to your account to ensure remote access to the device's settings.

To bind a new EcoFlow device:

1. Visit the EcoFlow app and log into your EcoFlow account.
2. Tap the Add Device button or **+** icon in the top right corner to search for new EcoFlow devices.
3. Select your EcoFlow device and follow the pop-up instructions to complete device binding and Wi-Fi setup.



Tips:

1. Unable to discover this power station via Bluetooth? Try the following:

- a. **Power-off:** Press and hold the Main Power button for 2 seconds to turn off the power station.
- b. **Reset Bluetooth:** While the power station is turned off, press and hold the Main Power button for at least 5 seconds after the screen turns on to reset all Bluetooth and Wi-Fi connections.
- c. **Power on & Retry:** Press and hold the Main Power button for 2 seconds to turn on the power station, and start searching again.
- d. If the problem persists, contact technical support.

2. Bluetooth Standby Tip: Bluetooth power standby is available on this power station. During Bluetooth power standby, this power station keeps Bluetooth enabled when it is turned off. This allows you to remotely turn on the power station via Bluetooth in the EcoFlow App. However, Bluetooth standby requires the consumption of some power. If you don't need this feature or want to shorten the time that Bluetooth power standby is active, you can adjust the Bluetooth Timeout setting in the EcoFlow app.

Control via Phone

With the EcoFlow app, you can manage all your EcoFlow binding devices on your phone.

The power station supports Wi-Fi and Bluetooth connections, adapting to varying network conditions to ensure convenient access to device settings.

- **With Internet**

When Wi-Fi is stable, you can access the device settings via the internet. This method is always recommended to ensure your EcoFlow device can receive timely firmware updates and pushes.

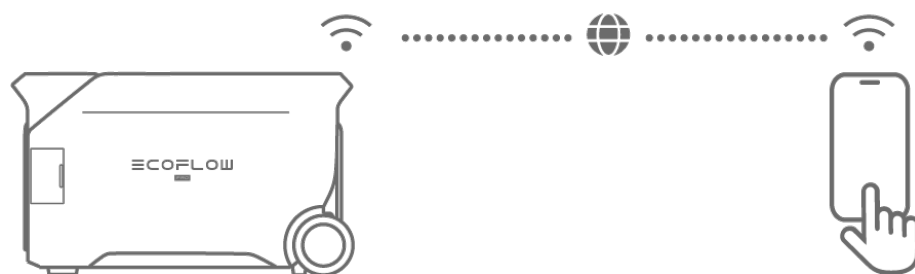

- **Without Internet**

If the Wi-Fi connection is limited, you can manage the power station locally via Bluetooth.



Control via EcoFlow PowerInsight

EcoFlow PowerInsight is an energy manager for your power system - from generation to storage and consumption. It can also integrate devices from other brands via the Matter protocol, including thermostats for adjusting room temperature, smart plugs for monitoring consumption and controlling appliance power, and smart light bulbs for managing lighting.

For more information about how to use EcoFlow PowerInsight, visit:

<https://manuals.ecoflow.com/product/powerinsight>



Explore More

Enhance System Safety

The DELTA Pro 3 is designed to be safe with an insulation enclosure and various protection features. However, if you need to operate the power station in a wet environment, or in any other situation prone to potential electrical hazards, enhance safety by using it with a ground fault circuit interrupter (GFCI) or residual current device (RCD).

When using a GFCI/RCD, enable the "GFCI Support" feature in the EcoFlow app. This feature uses the neutral line to simulate the grounding of the grid's neutral conductor, completing the GFCI's detection circuit so that the GFCI can trip when current leakage is detected.



Tip:

The GFCI Support feature is not required if the power station is in bypass mode.

Expand Battery Capacity

If you frequently encounter power-intensive scenarios or require prolonged usage during power outages, you can proactively install extra battery capacity. This power station supports connecting up to 2 extra batteries to expand capacity.

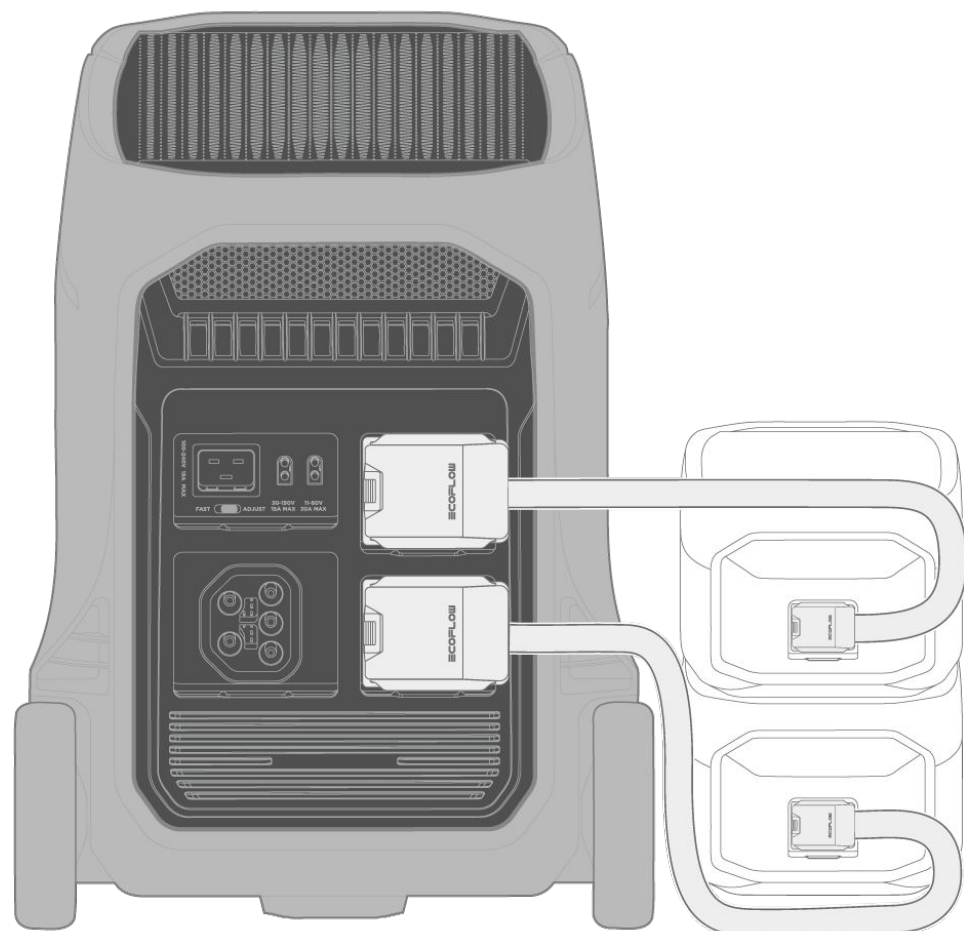

- **To Connect the Extra Battery**

1. Connect the extra battery to the power station's Extra Battery port.
2. The extra battery is considered successfully installed once the battery icon is displayed on the screen of the power station.

- **To Remove the Extra Battery**

Directly remove the connection between the power station and the extra battery.



Tip:

The power station is backwards compatible with the [DELTA Pro Smart Extra Battery](#).

Maximize Power Output

X-Fusion: Optimal Power Capacity

X-Fusion is an advanced technology that ensures all AC output sockets provide optimal output when the product is in bypass mode (when you recharge and discharge the power station simultaneously, the power station enables bypass mode automatically), in terms of wattage and amp.

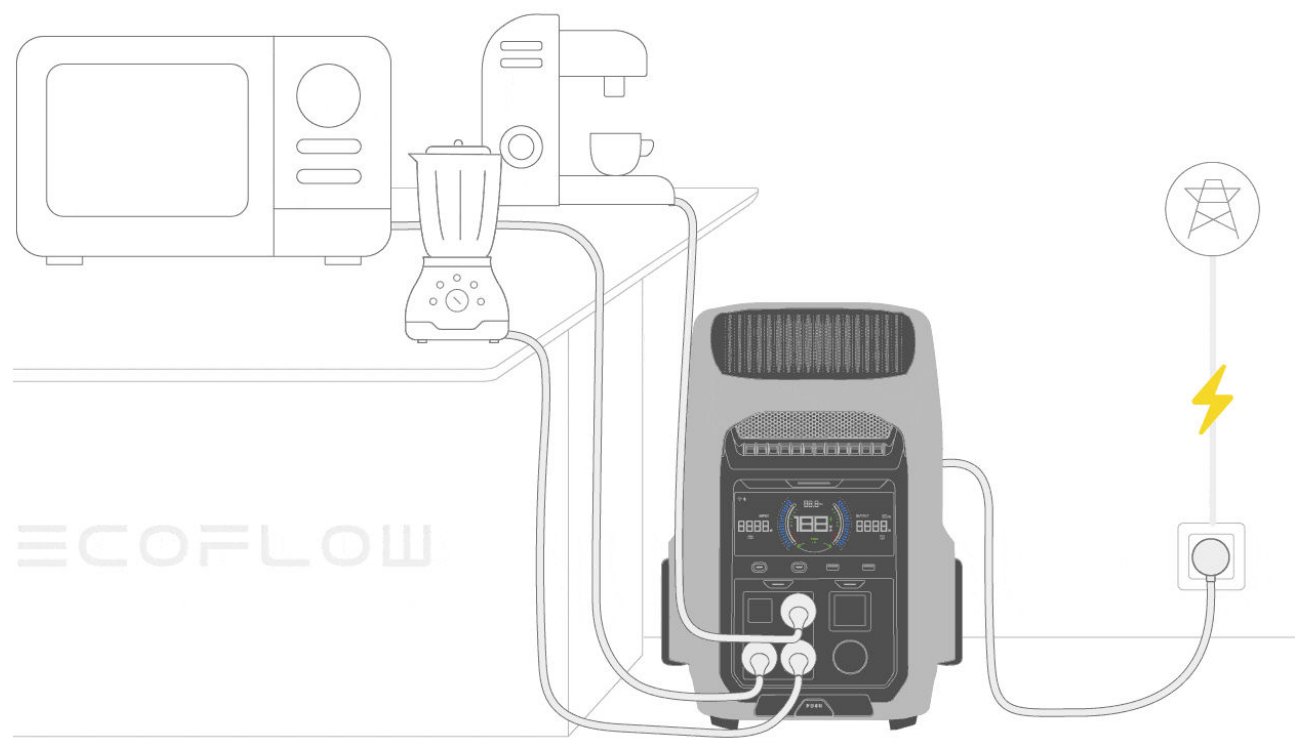

Tips:



1. X-Fusion is a built-in feature that requires no additional configuration.
2. The power station can provide up to its maximum rated power no matter how much the input is.

X-Boost: Powering High-Wattage Appliances

X-Boost is an innovative technology exclusive to EcoFlow power stations. It allows the power station to support appliances with a higher power requirement than its rated power output.

- **How do I use this feature?**

X-Boost is disabled by default. To use it:

1. Connect any high-wattage appliance to an AC output socket on the power station.
2. Open the EcoFlow app and log into your EcoFlow account.
3. Turn on X-Boost in the device's settings.

- **What kind of devices does X-Boost support?**

X-Boost is more suitable for heating devices, such as an electric blanket, a water heater, or a heat pump. X-Boost does not support devices with voltage protection (such as precise instruments). If such devices are connected, they may stop working due to low voltage.



Tip:

X-Boost is unavailable when the power station is being charged via an AC power source (i.e. when the power station is in bypass mode).

- **Reference: Power with X-Boost Feature**

Versions	Rated Power (W)	Power with X-Boost (W)
US	4000	6000
JP	3600	5100
CN	4000	6000
UK	4000	6000

EU	4000	6000
AU	4000	6000
CH	4000	6000
ZA	4000	6000

Paralleling Power Stations

Paralleling the power stations to significantly increase the power output and storage capacity. Utilize this configuration for various high power-demand scenarios, such as off-grid living, emergency backup, or construction sites.

Method 1: Dual Power Station Configuration with EcoFlow 50 Amp Hub

Use [EcoFlow 50 Amp Hub](#) and [EcoFlow Power Input/Output Cable](#) to connect two DELTA Pro 3 to double the power output. Then connect your loads to the EcoFlow 50 Amp Hub with a NEMA 14-50P cable.

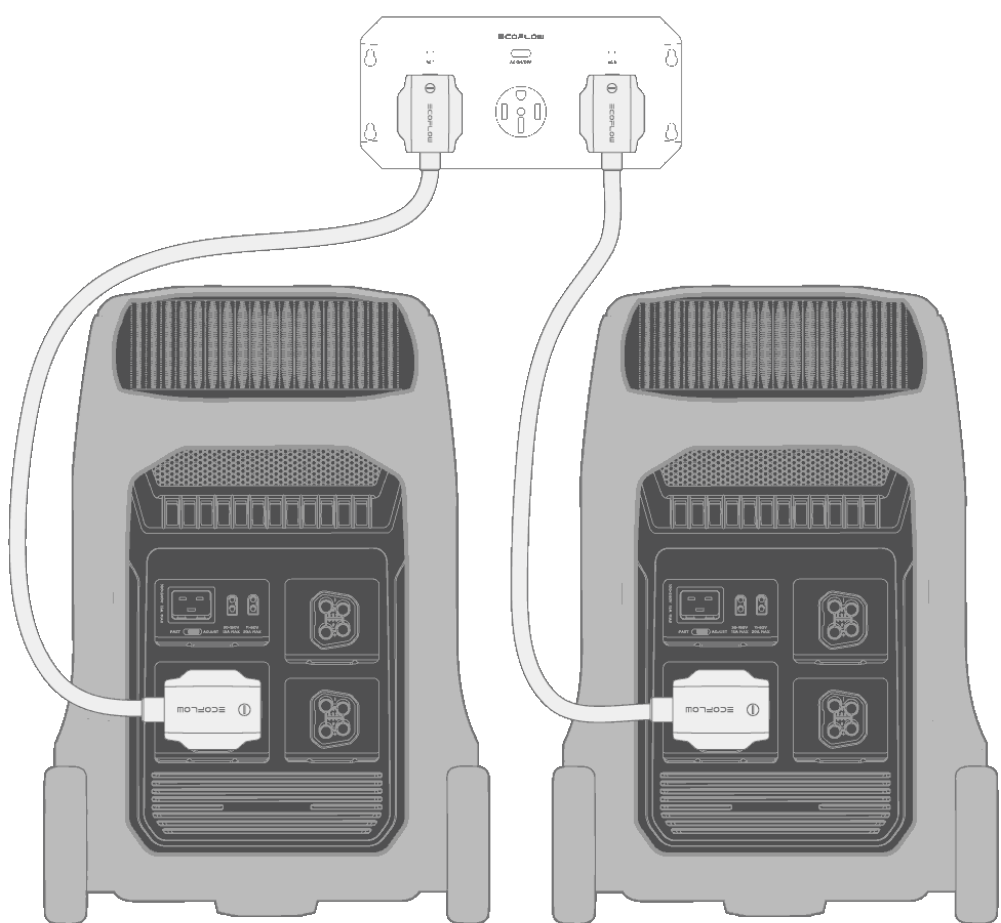

 **Tip:** For the US version, the maximum output current in this setup is 33 amps.

Method 2: Triple Power Station Configuration with EcoFlow Smart Home Panel 2

Use [EcoFlow Smart Home Panel 2](#) and [EcoFlow Power Input/Output Cable](#) to connect three DELTA Pro 3 to triple the power output. The EcoFlow Smart Home Panel 2 can also be connected to your main panel to collectively manage circuits for your home.

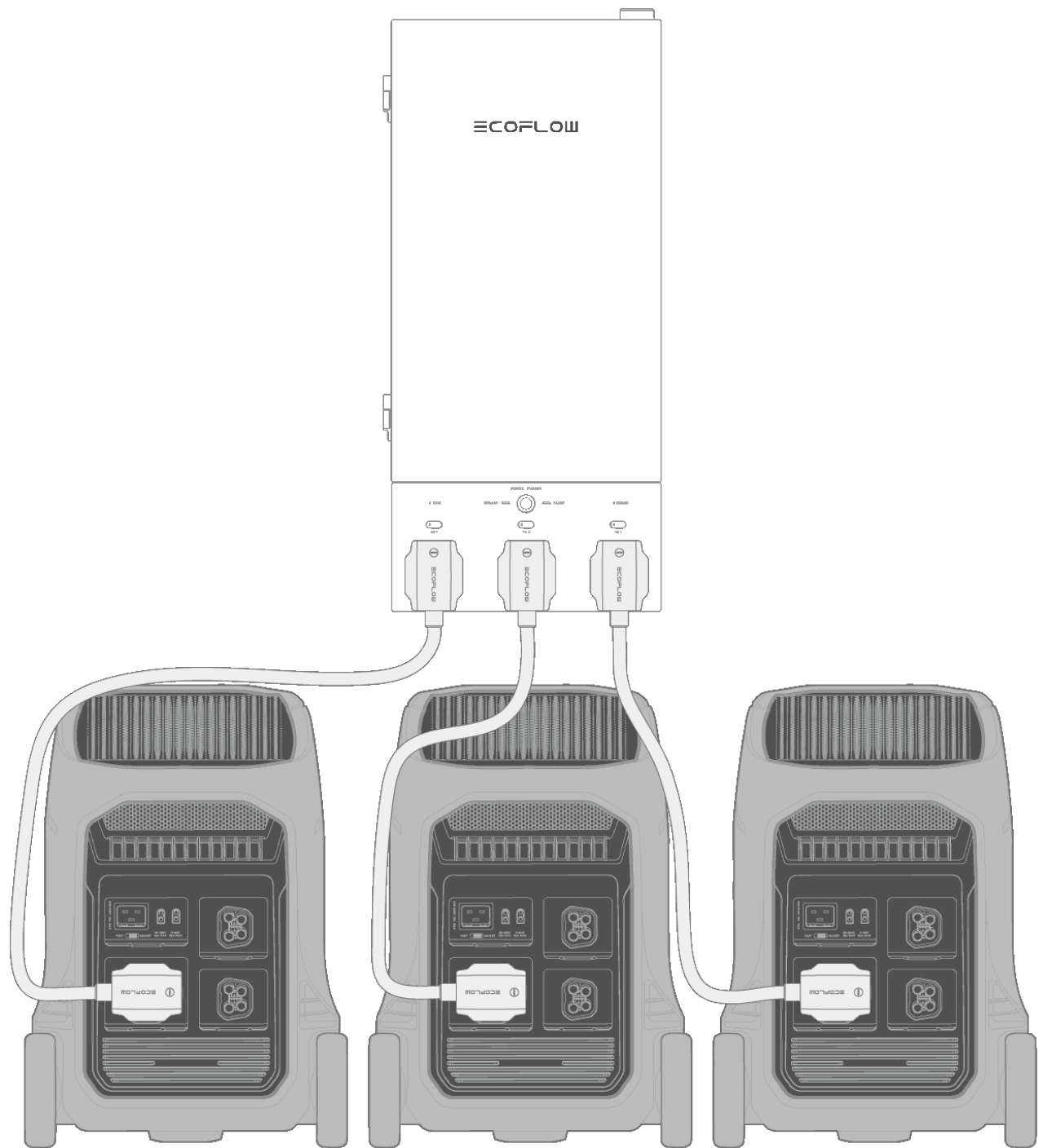

Notice:

- i** When the AC POWER IN / OUT port is being used, all AC output sockets and AC input socket will be disabled.

Build a Backup System

Uninterrupted Power Supply (UPS): Backup for Essential Devices

A UPS is a device or system that provides a continuous supply of backup power when grid electricity fails. You can use the power station as a UPS to support essential household appliances. The power station acts as a standby UPS with a transfer time of 10 ms. When a power outage occurs and appliances can no longer use power from the grid, the power station automatically transfers its battery power for use by connected appliances.

- **How do I use this feature?**
 1. Connect the power station to a wall outlet to access grid power.
 2. Connect any appliances to this power station so the power station can provide them with power to operate during a power outage.

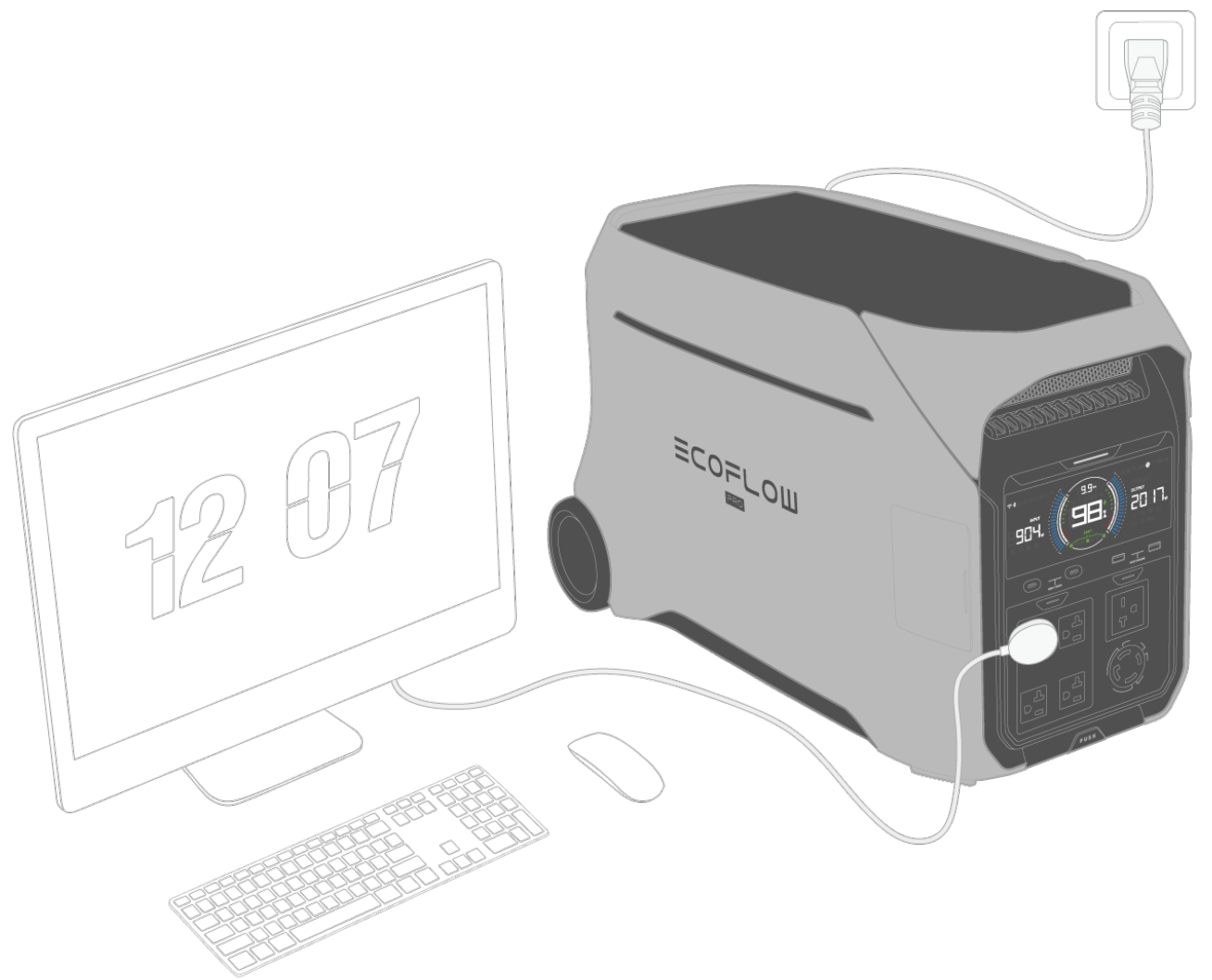

Note: In this setup, the power station requires more power input from the grid than it provides to any connected loads so it can use surplus power to charge and maintain its batteries. Otherwise, the power station is unable to function as a UPS since its batteries won't have a charge.

Backup for Home

The extendable battery capacity and various socket types makes DELTA Pro 3 an energy storage module to reduce energy waste, and also a stable backup power source during blackouts.

1. Traditional Backup Scheme

Utilize your existing power inletbox and transfer switch to use with DELTA Pro 3. The DELTA Pro 3 stores the energy generated by solar panels while your home appliances run normally on grid power. When needed, use the transfer switch to switch the power source for your household loads to the power station.

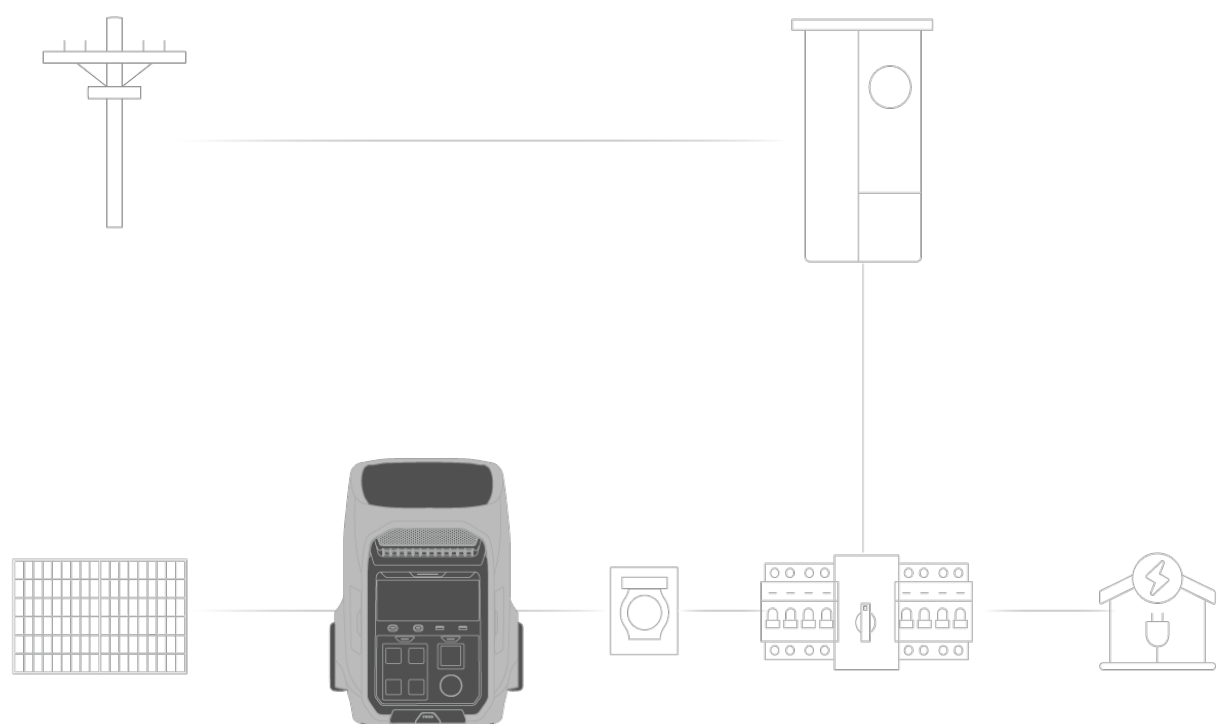



Notice:

A transfer switch is essential to safely isolate backup power from the grid power. DO NOT hook up a power station to the electrical system of a building without a properly installed isolation switch. Please comply with all applicable laws and electrical regulatory requirements.

2. EcoFlow PowerStream Balcony Solar System

Use [EcoFlow PowerStream Microinverter](#), DELTA Pro 3, and solar panels to build a simple PV-storage system. In this setup, the DELTA Pro 3 stores excess electricity generated by solar panels and supplies it to the home during the night or during power outages.

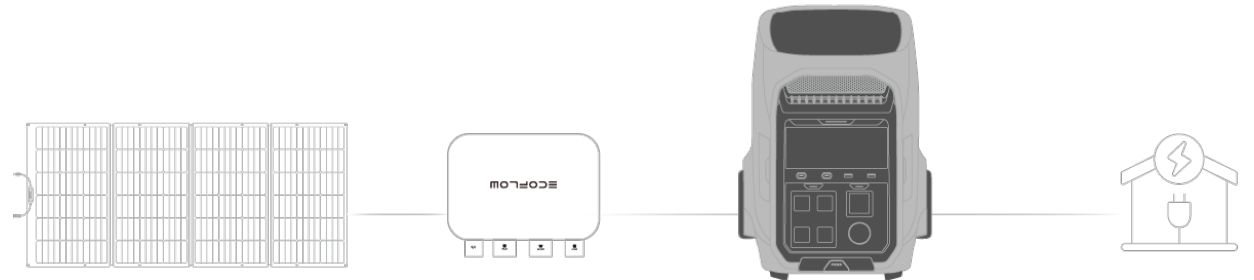

Notice:

Due to the differences in electrical regulations between different countries and regions, we recommend that you familiarize yourself with your local legal requirements and consult with qualified electrical professionals in your area before making a purchase. Please ensure that the product can be installed and used in accordance with the regulatory requirements of your country/region.



Tip:

To learn more about EcoFlow PowerStream, visit:
<https://eu.ecoflow.com/pages/powerstream>

3. EcoFlow Smart Home Backup

Use EcoFlow devices to build a smart power management ecosystem. You can customize your home power plan through the EcoFlow app or [PowerInsight](#). The [Smart Home Panel 2](#) acts as the hardware hub, controlling the DELTA Pro 3 to execute AC charging and discharging strategies. In the event of an unexpected power outage, the Smart Home Panel 2 will automatically switch your home's power supply from the grid to the energy storage module.

Under normal circumstances, the DELTA Pro 3 can be recharged through the grid, solar power, or an EcoFlow smart generator, ensuring that your home always has sufficient power reserves.

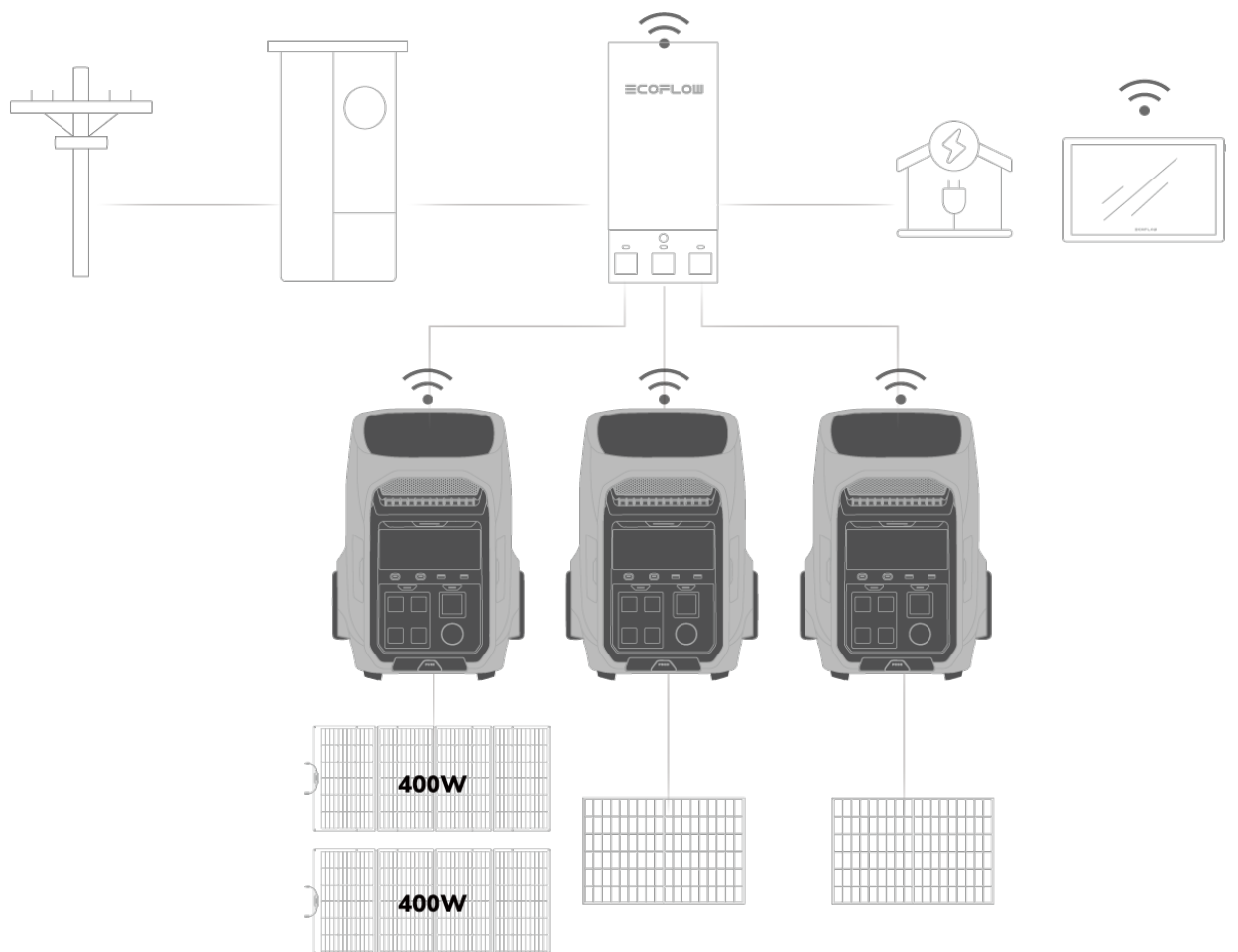

Storage and Maintenance

1. Storage

- Storage Temperature: 14°F-113°F (-10°C to 45°C)
- Do not store the product in places where the temperature exceeds 113°F (45°C) or falls below 14°F (-10°C).
- Store the product in a tidy, dry, and well-ventilated place.
- Keep the product away from liquids, intense heat, and sharp objects.
- For long-term storage of the product, follow these steps every 3 months to maintain battery health:
 1. Discharge the product to 0% battery level.
 2. Fully charge the product to 100% battery level.
 3. Discharge the product again to 60% battery level.

Note: the product will not be covered by the warranty if it is not charged or discharged for more than 6 months.

2. Maintenance

- **Cleaning**
Use a soft, dry cloth to wipe and clean the product.
- **Maintaining Battery Health**
Avoid leaving the product unused for extended periods of time.
Charge and discharge the product every 3 months to increase its lifespan.

Safety Instructions and Compliances

Disclaimer

Please read the product document and ensure that you understand it fully before using the product. After reading this document, keep it for future

reference. Improper use of this product may cause serious injury to yourself or others, or cause product damage and property loss. Once you use this product, it is deemed that you understand, approve and accept all the terms and content in this document. EcoFlow is not liable for any loss caused by the user's failure to use the product in compliance with the product document. In compliance with laws and regulations, EcoFlow reserves the right to the final interpretation of this document and all documents related to the product. This document is subject to changes (updates, revisions, or termination) without prior notice. Please visit EcoFlow's official website to obtain the latest product information: <https://www.ecoflow.com/>.

Safety Instructions

1. Do not subject this product to severe impacts, vibrations, or drops.
2. Do not carry this product onto a plane.
3. Do not use the product near a heat source, such as a fire source or a heating furnace.
4. Do not get the product wet or immerse it in any liquid. When using the product in wet environments like rainy areas or places near water, protect it with a waterproof bag.
5. Follow the environment temperature requirements specified in the product specification to use or store the product. Avoid degradation or damage to the product, or risks to personal safety due to excessively high or low temperatures.
6. Do not use the product in an environment with strong static electricity or magnetic fields.
7. Keep the product out of reach of children and pets. If the product is to be used near children, they should be closely supervised.
8. Keep the product away from fumes, smoke, steam, and dust.
9. Store the product in a tidy, dry, and well-ventilated place.
10. Do not disassemble, repair, or modify this product by yourself. For any maintenance or service, please contact EcoFlow Customer Service.
11. Always disconnect the product from all external power sources before attempting any service or maintenance.
12. To reduce risk of damage to the electric plug and cord, pull the plug rather than the cord when disconnecting the product.
13. Do not pierce the product with sharp objects.
14. Do not put fingers or hands into the product.
15. Do not insert wires or other metal objects into the product to prevent short circuits.
16. Do not block or restrict the heat dissipation system of the product during operation.
17. Do not use any unofficial or unrecommended components or accessories. For any replacements, please contact EcoFlow for further assistance.
18. Do not operate this product with a damaged cord or plug, or a damaged output cable.
19. Do not stack any heavy objects on the product.
20. Place the product on a stable and flat surface. Avoid damage to the device or personal injury due to the product falling or tipping over.
21. Use a soft, dry cloth to wipe and clean the product.
22. **AC Timeout Tip:** The AC output port of the power station will automatically turn off if the port is idle for a certain period. When the power station is connected to intermittent loads like refrigerators or air conditioners, this

feature may be triggered. To ensure continuous power supply for critical uses, such as storing medicines, vaccines, the perishables, or other valuable items in a refrigerator, set the power station's AC timeout interval to never in the EcoFlow app. Additionally, regularly check the power station's battery level.

23. **Medical Equipment Limit:** The product is not intended for powering life-sustaining medical equipment, including but not limited to medical-grade ventilators (hospital-grade CPAP: Continuous Positive Airway Pressure) or artificial lungs (ECMO: Extracorporeal Membrane Oxygenation). If you plan to use it for other medical equipment, consult with the equipment's manufacturer first to ensure there are no restrictions on using an external power source with their equipment.
24. **Medical Equipment Interference:** When in use, power supply products will generate electromagnetic fields, which are likely to affect the normal operation of medical implants or personal medical equipment such as pacemakers, cochlear implants, hearing aids, defibrillators, etc. If these types of medical equipment are being used, please contact the manufacturer to inquire about any restrictions on the use of such equipment. These measures are fundamental to ensure a safe distance between the medical implants (for example, pacemakers, cochlear implants, hearing aids, defibrillators, etc.) and this product while in use.
25. **Risk of Electric Shock:** Never use the product to power tools to cut or access live parts or live wirings, or materials that may contain live parts or live wirings inside, such as building walls, etc.
26. **GROUNDING INSTRUCTIONS:** This product must be grounded. If it should malfunction or breakdown, grounding provides a path of least resistance for electric current to reduce the risk of electric shock. For your safety, EcoFlow provides a cord with an equipment grounding conductor and a grounding plug. The plug must be plugged into an outlet that is properly installed and grounded in accordance with all local codes and ordinances. **WARNING** – Improper connection of the equipment grounding conductor can result in a risk of electric shock. If you encounter the following situations, consult a qualified electrician instead of modifying the plug provided with the product:
 - You are unsure whether the product is properly grounded;
 - You find that the plug provided with the product does not fit the outlet.
27. **Use in Repair Facility:** During use in a repair facility like a vehicle repair center, workshop, or any other place where repairs are conducted, do not place the product on the floor, or at a height less than 457 mm (18 inches) above the floor.

In Case of Emergency

1. In case of emergency, take precautions against electric shock before touching the product, such as wearing insulating gloves.
2. If the product gets wet, stop using it immediately and refrain from further operation or powering it on. Place the product in a secure, waterproof, and well-ventilated area, then contact EcoFlow Customer Service for assistance.
3. If the product falls into water, place it in a secure, waterproof, and well-ventilated area, and keep it away from contact until it is completely dry. The dried product should not be used again and must be properly disposed of according to local laws and regulations.

4. If the product catches fire, we recommend that you use the fire extinguishers in the following order: water or water mist, sand, fire blanket, dry powder, and finally a carbon dioxide fire extinguisher.
5. If the product is overturned and severely damaged, wear insulating gloves to turn it off, and then place the product in an open area far from flammable materials and people., and dispose of it according to local laws and regulations.

Recycling and Disposal

1. The product with severe damage, malfunction, or depleted battery life should be properly disposed of or recycled.
2. The product contains batteries. Please dispose of the product following local laws and regulations for battery disposal and recycling. Do not dispose of it with household waste to avoid environmental pollution and safety hazards.
3. If possible, ensure the battery is completely discharged (to 0% capacity) before disposing of the product. If not, refrain from placing the battery directly into a battery recycling box. Instead, contact a professional battery recycling company for proper handling.

Regulatory Compliance

FCC Compliance Statement

Any Changes or modifications not expressly approved by the party responsible for compliance could void the user's authority to operate the equipment.

This device complies with part 15 of the FCC Rules. Operation is subject to the following two conditions:

- (1) This device may not cause harmful interference, and
- (2) this device must accept any interference received, including interference that may cause undesired operation.

Note: This equipment has been tested and found to comply with the limits for a Class A digital device, pursuant to part 15 of the FCC Rules. These limits are designed to provide reasonable protection against harmful interference when the equipment is operated in a commercial environment. This equipment generates, uses, and can radiate radio frequency energy and, if not installed and used in accordance with the instruction manual, may cause harmful interference to radio communications. Operation of this equipment in a residential area is likely to cause harmful interference in which case the user will be required to correct the interference at his own expense.

This equipment complies with FCC radiation exposure limits set forth for an uncontrolled environment.

This equipment should be installed and operated with a minimum distance of 20 cm between the radiator & your body.

IC Compliance Statement

When using the product, maintain a distance of 20 cm from the body to ensure compliance with RF exposure requirements.

This device complies with Industry Canada licence-exempt RSS standard(s).

Operation is subject to the following two conditions:

- (1) this device may not cause interference, and
- (2) this device must accept any interference, including interference that may

cause undesired operation of the device.

This Class A digital apparatus complies with Canadian ICES-003.

Il doit être installé et utilisé à une distance minimale de 20 cm entre le radiateur et toute partie de votre corps.

Le présent appareil est conforme aux CNR d'Industrie Canada applicables aux appareils radio exempts de licence. L'exploitation est autorisée aux deux conditions suivantes:

(1) l'appareil ne doit pas produire de brouillage, et

(2) l'utilisateur de l'appareil doit accepter tout brouillage radioélectrique subi, même si le brouillage est susceptible d'en compromettre le fonctionnement.

Cet appareil numérique de la classe A est conforme à la norme NMB-003 du Canada.



CE

Hereby, EcoFlow Inc. declares that the radio equipment type portable power station is in compliance with Directives 2014/53/EU, 2011/65/EU(RoHS), (EU) 2015/863(RoHS). The full text of the EU Declaration of Conformity is available at the following Internet address:

<http://www.ecoflow.com/eu/eu-compliance>



WEEE

This marking indicates that this product should not be disposed of with other household waste within the EU. Recycle this product properly to prevent possible damage to the environment or a risk to human health via uncontrolled waste disposal and in order to promote the sustainable reuse of material resources. Please return your used product to an appropriate collection point or contact the retailer where you purchased this product. Your retailer will accept used products and return them to an environmentally-sound recycling facility.

Appendix

What's in the Box



1. EcoFlow DELTA Pro 3 ×1
2. AC Charging Cable ×1
3. Grip Protector ×2
4. Product Document Bundle ×1





If any item is damaged or missing, contact EcoFlow Customer Service for assistance.



Accessory List

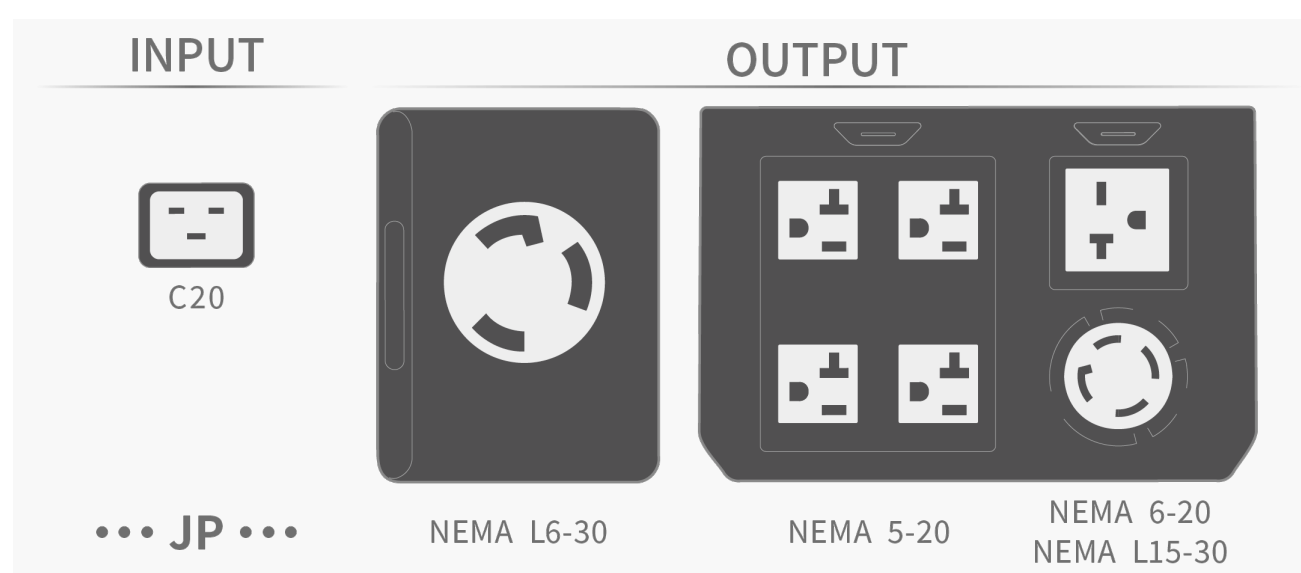
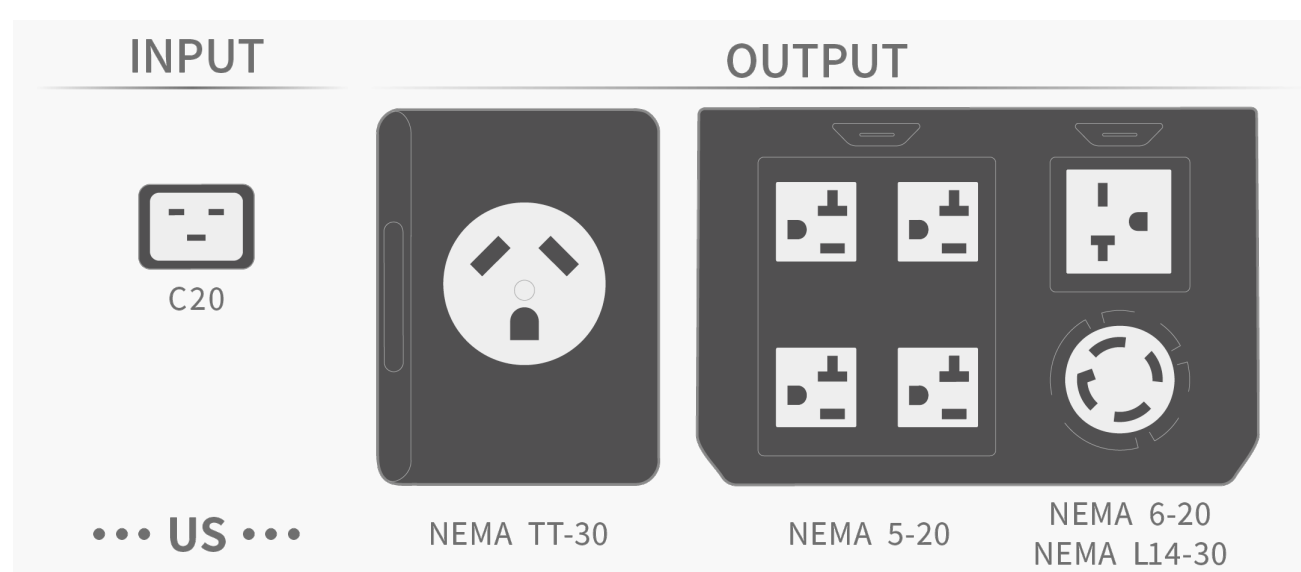

[View More](#)

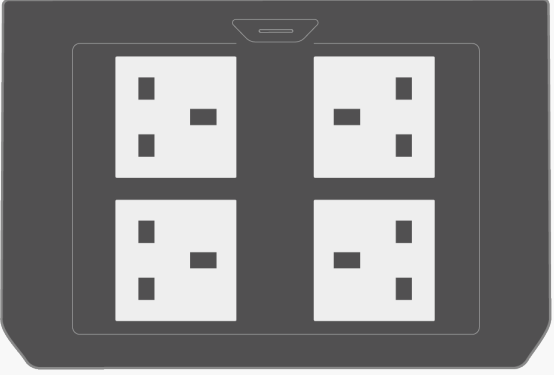

AC Socket Types by Version

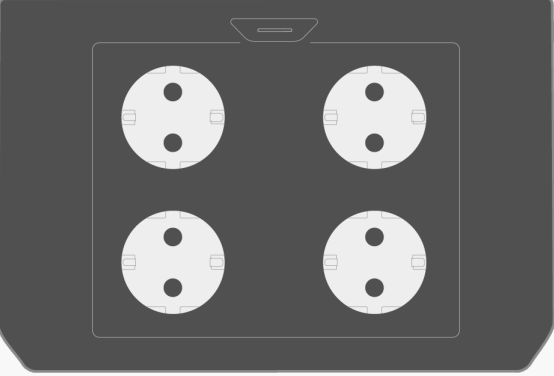

INPUT	OUTPUT	
 <p>C20</p>	 <p>CEE 16A</p>	 <p>TYPE G</p>
... UK ...		

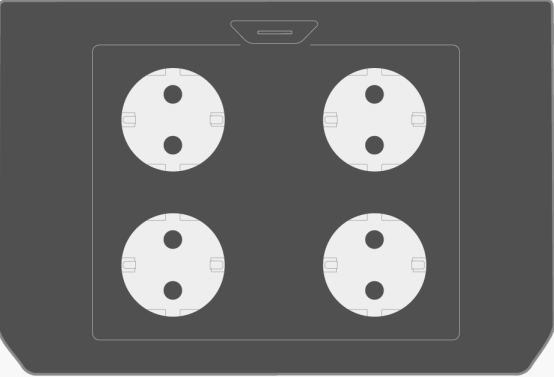
INPUT	OUTPUT	
 <p>C20</p>	 <p>CEE 16A</p>	 <p>TYPE F</p>
... EU ...		

INPUT	OUTPUT	
 <p>C20</p>	 <p>CEE 16A</p>	 <p>TYPE F</p>
... KR ...		

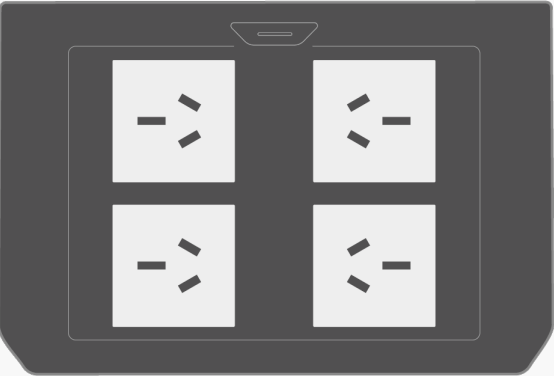
INPUT	OUTPUT	
 <p>C14</p>	 <p>CEE 16A</p>	 <p>TYPE I</p>
... AU ...		

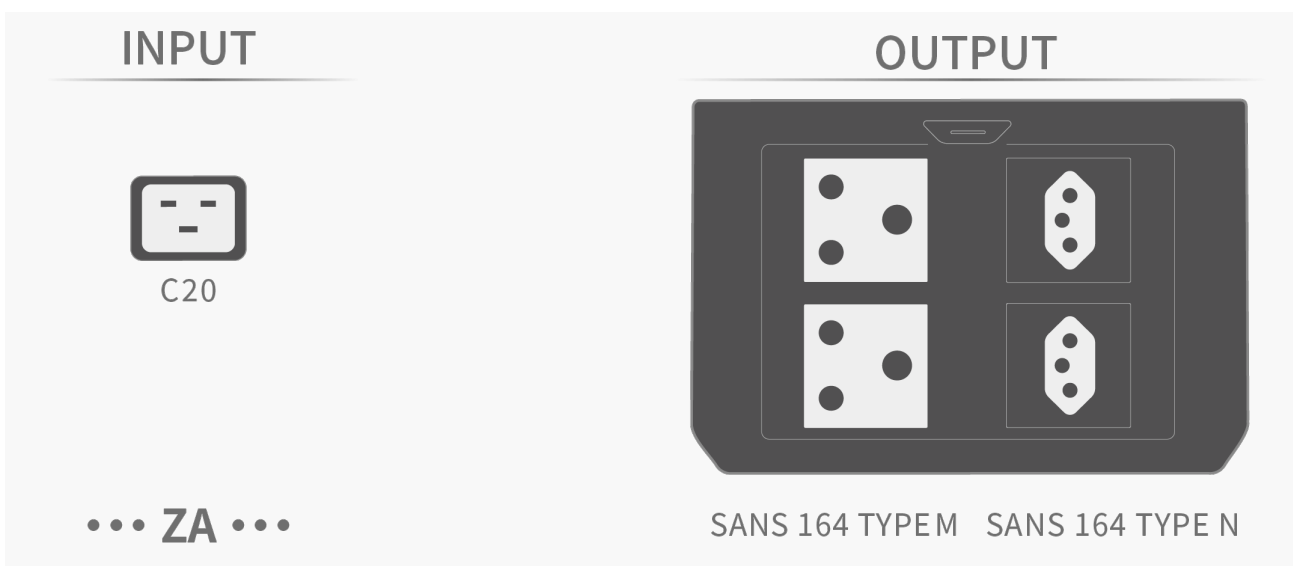
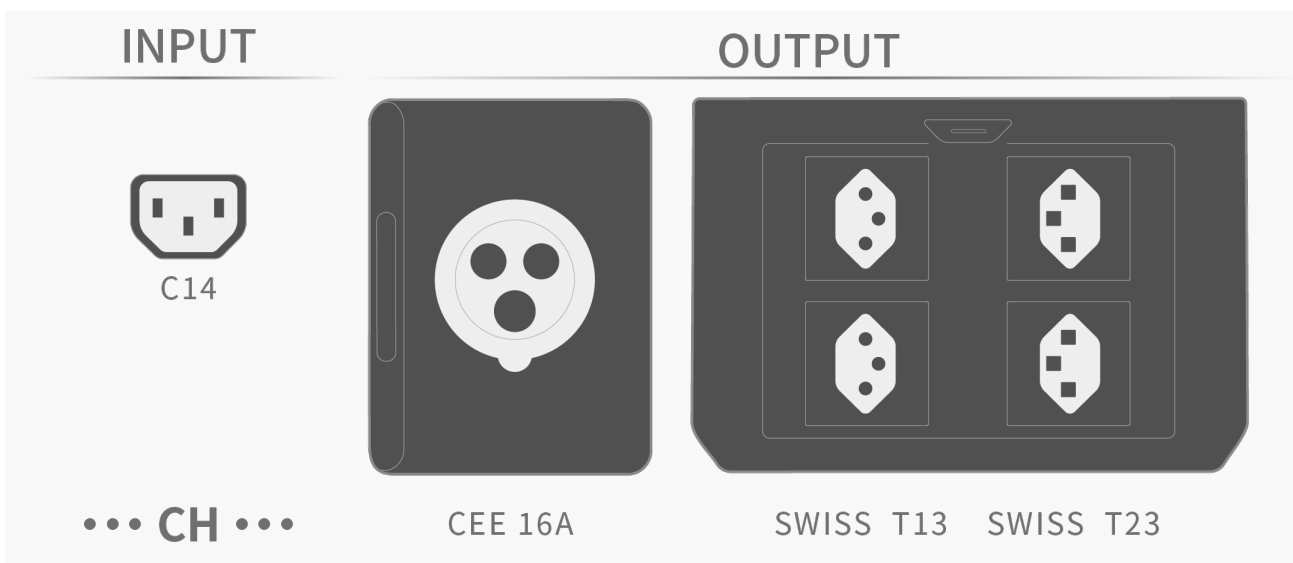

Technical Specifications

General	
Model	EFD521
Net. Weight	Approx. 51.5 kg (113.54 lb)
Dimensions (WxDxH)	Approx. 410.4 x 341 x 693 mm (16.16 x 13.43x 27.28 in.)
AC Output	
Wave Form	Pure sine wave
Socket Type	<p>US:</p> <ul style="list-style-type: none"> • Low-voltage / Single phase: 4x NEMA 5-20R, 120V~20A; 1x NEMA TT-30R, 120V~30A • High-voltage / Split phase: 1x NEMA L14-30R, 120V/240V~16.7A; 1x NEMA 6-20R, 240V~16.7A <p>JP:</p> <ul style="list-style-type: none"> • Low-voltage / Single phase: 4x NEMA 5-20R, 100V~20A; 1x NEMA L6-30R, 100V~30A • High-voltage / Split phase: 1x NEMA L15-30R, 100V/200V~18A; 1x NEMA 6-20R, 200V~18A <p>CN: 2x Standard Five-pin Socket, 220V~10A; 2x Standard Three-pin Socket, 220V~16A</p> <p>UK: 4x Type G, 230V~13A; 1x CEE 16A, 230V~16A</p> <p>EU:</p>

4× Type F, 230V~16A; 1× CEE 16A, 230V~16A

KR:

4× Type F, 220V~16A; 1× CEE 16A, 220V~16A

AU:

4× Type I, 230V~15A; 1× CEE 16A, 230V~16A

CH:

2× Swiss T13, 230V~10A; 2× Swiss T23, 230V~16A; 1× CEE 16A, 230V~16A

ZA:

2× SANS 164 Type N, 230V~16A; 2× SANS 164 Type M, 230V~16A

US:

• Discharge Only:

120V~60Hz 4000W total (surge 8000W)

120/240V~60Hz 4000W total (surge 8000W)

• Bypass Mode:

100-120V~50/60Hz 4000W total

JP:

• Discharge Only:

100V~60Hz 3600W total (surge 7200W)

100/200V~60Hz 3600W total (surge 7200W)

• Bypass Mode:

100-120V~50/60Hz 3600W total

CN:

• Discharge Only: 220V~50Hz 4000W total (surge 8000W)

• Bypass Mode: 220-240V~50/60Hz 4000W total

UK:

• Discharge Only: 230V~50Hz 4000W total (surge 8000W)

• Bypass Mode: 220-240V~50/60Hz 4000W total

EU:

• Discharge Only: 230V~50Hz 4000W total (surge 8000W)

• Bypass Mode: 220-240V~50/60Hz 4000W total

KR:

• Discharge Only: 220V~60Hz 4000W total (surge 8000W)

• Bypass Mode: 220-240V~50/60Hz 4000W total

AU:

• Discharge Only: 230V~50Hz 4000W total (surge 8000W)

• Bypass Mode: 220-240V~50/60Hz 4000W total

CH:

• Discharge Only: 230V~50Hz 4000W total (surge 8000W)

• Bypass Mode: 220-240V~50/60Hz 4000W total

ZA:

• Discharge Only: 230V~50Hz 4000W total (surge 8000W)

• Bypass Mode: 220-240V~50/60Hz 4000W total

Output Details

EcoFlow Proprietary Port

US:

Discharge Only: 120/240V~16.7A 60Hz

JP:

Discharge Only: 100V/200V~18A 60Hz

CN:

Discharge Only: 220V~18A 50Hz

UK:

Discharge Only: 230V~17.4A 50Hz

EU:

Discharge Only: 230V~17.4A 50Hz

AC POWER
IN/OUT Port

KR:

Discharge Only: 220V~18A 60Hz

AU:

Discharge Only: 230V~17.4A 50Hz

CH:

Discharge Only: 230V~17.4A 50Hz

ZA:

Discharge Only: 230V~17.4A 50Hz

DC Output

USB Output

2 xUSB-A (QC3.0): 5V==2.4A / 9V==2A / 12V==1.5A, 18W Max per port, 36W total

2 xUSB-C (PD3.0): 5 / 9 / 12 / 20V==5A, 15V==3A, 100W Max per port, 200W total

12V DC Output

12.6V==30A, 378W total

- DC5521 port: 5A Max
- Anderson port: 30A Max

AC Input

Socket Type

US / JP / UK / EU / KR / ZA: C20**CN / AU / CH:** C14

Input Details

US:

- Charge Only: 100-240V~15A 50/60Hz
- Bypass Mode: 100-120V~15A (3 hours Max), 12A (continue), 50/60Hz

JP:

- Charge Only: 100-240V~15A 50/60Hz
- Bypass Mode: 100-120V~15A 50/60Hz

CN:

- Charge Only: 220-240V~10A 50/60Hz
- Bypass Mode: 220-240V~10A 50/60Hz

UK:

- Charge Only: 220-240V~12.5A 50/60Hz
- Bypass Mode: 220-240V~12.5A 50/60Hz

EU:

- Charge Only: 220-240V~12.5A 50/60Hz
- Bypass Mode: 220-240V~12.5A 50/60Hz

KR:

- Charge Only: 220-240V~10A 50/60Hz
- Bypass Mode: 220-240V~10A 50/60Hz

AU:

- Charge Only: 220-240V~10A 50/60Hz
- Bypass Mode: 220-240V~10A 50/60Hz

CH:

- Charge Only: 220-240V~10A 50/60Hz
- Bypass Mode: 220-240V~10A 50/60Hz

ZA:

- Charge Only: 220-240V~12.5A 50/60Hz
- Bypass Mode: 220-240V~12.5A 50/60Hz

EcoFlow Proprietary Port

US:

Charge Only: 100/200V-120/240V~20A 50/60Hz

JP:

AC POWER IN/OUT Port	Charge Only: 220V-240V~20A 50/60Hz
	CN:
	Charge Only: 220V-240V~20A 50/60Hz
	UK:
	Charge Only: 220V-240V~20A 50/60Hz
	EU:
	Charge Only: 220V-240V~20A 50/60Hz
	KR:
	Charge Only: 220V-240V~20A 50/60Hz
	AU:
Charge Only: 220V-240V~20A 50/60Hz	
CH:	
Charge Only: 220V-240V~20A 50/60Hz	
ZA:	
Charge Only: 220V-240V~20A 50/60Hz	

DC Input

High-PV Input	XT60 Port 30V-150V \approx , 15A, 1600W Max
---------------	--

Low-PV Input / Car Input	XT60i Port • PV Input: 11V-60V \approx , 20A, 1000W Max • Car Input: 12V \approx 8A Max / 48V \approx 20A Max
-----------------------------	---

Battery Info

Rated Capacity	4096Wh 51.2V \approx 80Ah
----------------	-----------------------------

Cell Chemistry	LFP (LiFePO4)
----------------	---------------

Cycle Life	The battery maintains 80%+ SoH (State of Health) after 4000 cycles at 0.5C/0.5C at 25°C (77°F)
------------	--

Protection Type	Over Voltage Protection, Overload Protection, Over Temperature Protection, Short Circuit Protection, Low Temperature Protection, Low Voltage Protection, Overcurrent Protection
-----------------	---

IP Rating	IP65 (Internal battery pack only)
-----------	-----------------------------------

Environment Temperature

Optimal Operating Temperature	20°C-30°C (68°F-86°F)
-------------------------------------	-----------------------

Charge Temperature	0°C-45°C (32°F-113°F)
-----------------------	-----------------------

Discharge Temperature	-10°C to 45°C (14°F-113°F)
--------------------------	----------------------------

Storage Temperature	-10°C to 45°C (14°F-113°F)
------------------------	----------------------------

Communications

Method	CAN, WLAN, Bluetooth
CAN	REMOTE Port (RJ45)
WLAN	<p>Wi-Fi 4 (802.11n)</p> <p>Frequency</p> <ul style="list-style-type: none"> • CN / BR / MX: 2400-2483.5 MHz • EU / JP / KR / AU: 2412-2472 MHz / 2422-2462 MHz • TW / US / CA: 2412-2462 MHz / 2422-2452 MHz <p>Maximum Output Power</p> <ul style="list-style-type: none"> • CN: ≤20dBm • US: 0.057W • CA: 0.1208W • EU: 15.44dBm • UK: 15.44dBm • AU: 15.44dBm • KR: 15.44dBm • JP: 7.40mW/MHz
Bluetooth	<p>Bluetooth 5.0</p> <p>Frequency</p> <ul style="list-style-type: none"> • CN / BR / MX: 2400-2483.5 MHz • EU / TW / US / CA / JP / AU: 2402-2480 MHz <p>Maximum Output Power</p> <ul style="list-style-type: none"> • CN: ≤20dBm • US: 0.0071W • CA: 0.0071W • EU: 0.27dBm • UK: 0.27dBm • AU: 0.27dBm • KR: 0.27dBm • JP: 7.7mW